

APPROX. WEIGHT (LBS)
43

ECO No	DESCRIPTION	REV BY	DATE
M10014	ADDED MOUNTING BRACKET TO REACTOR	MN	11/29/16

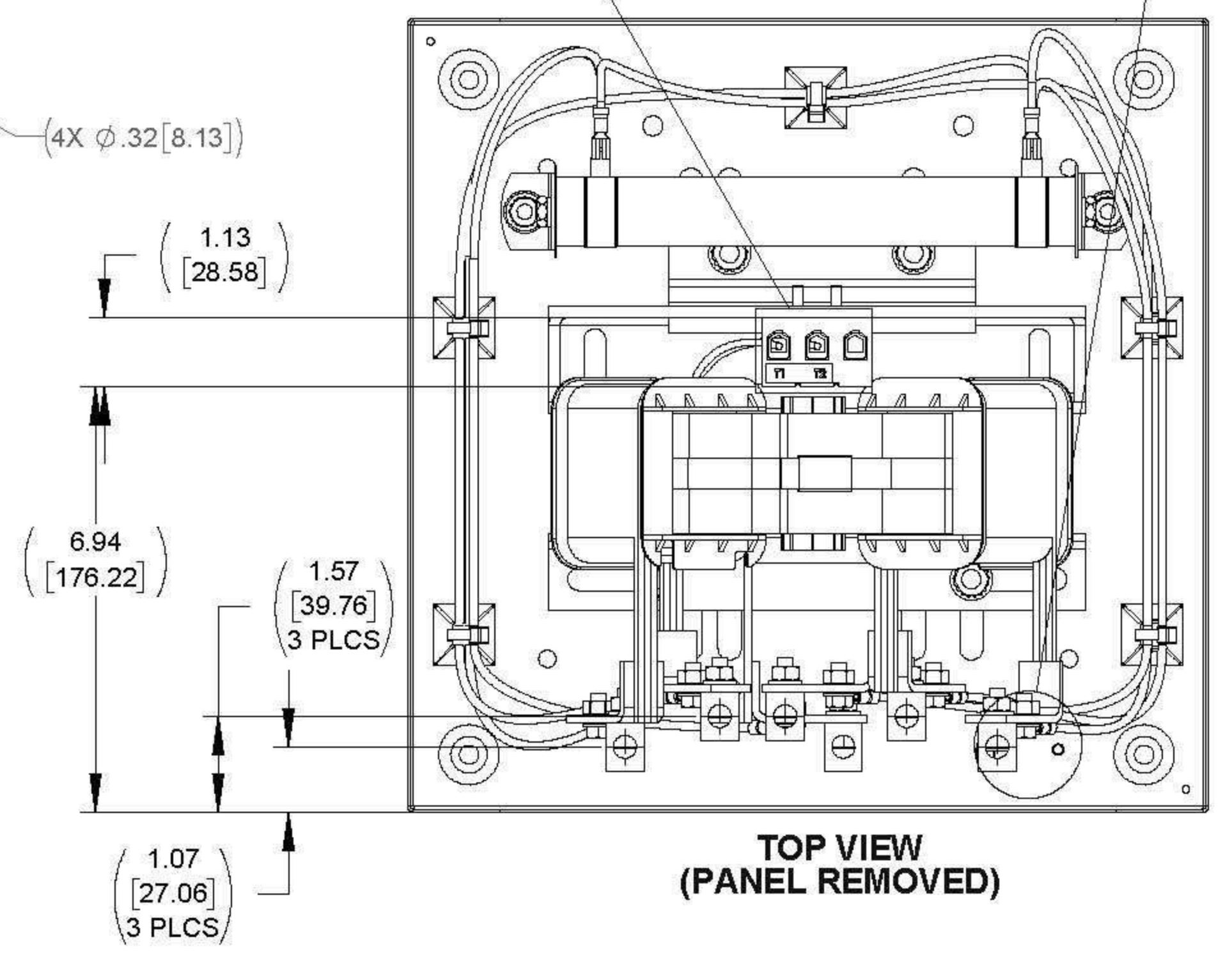
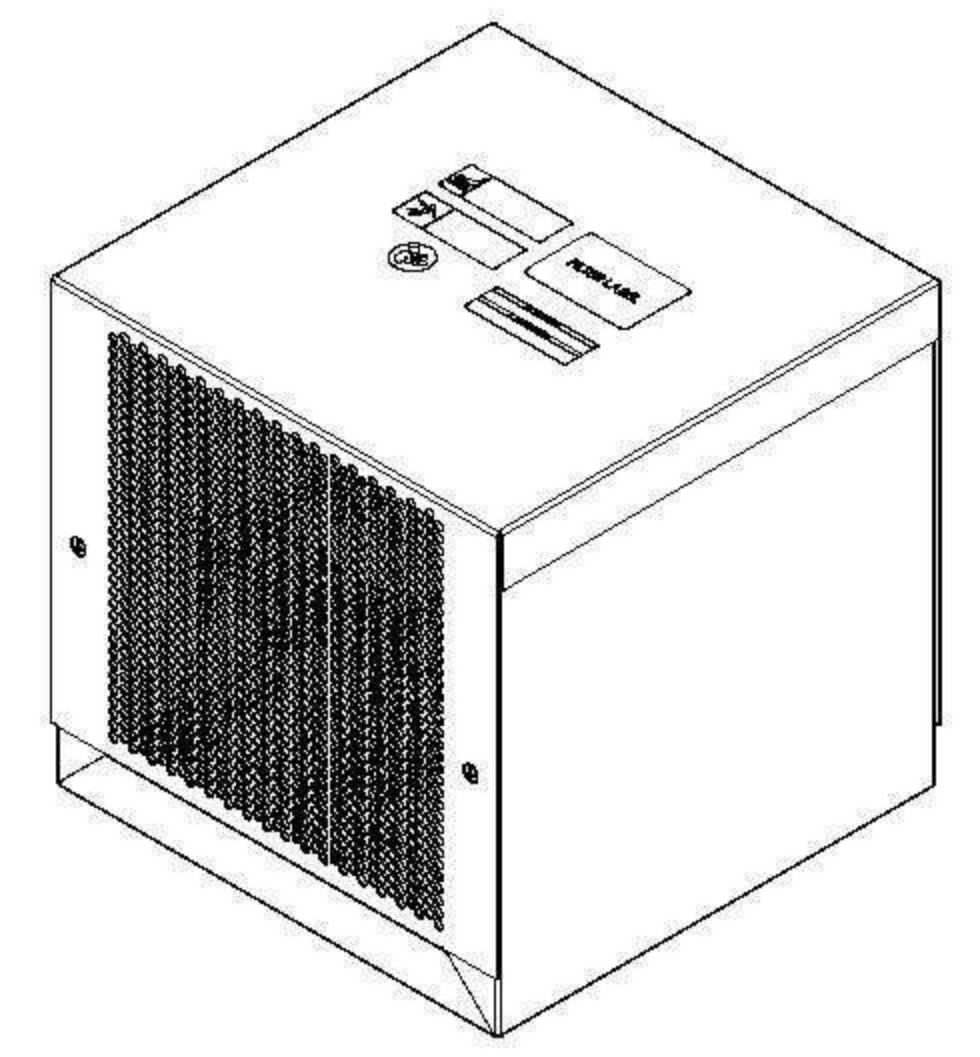
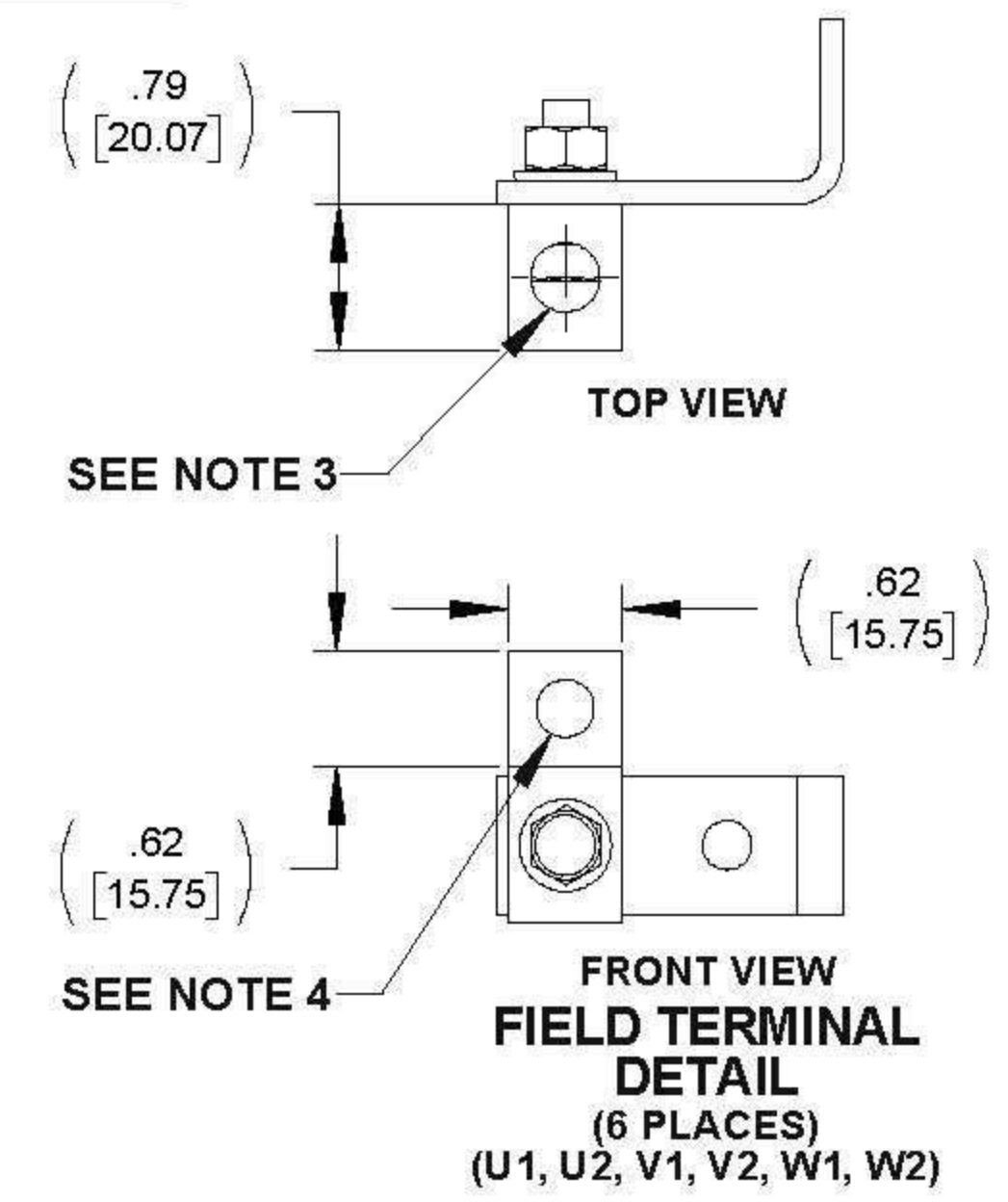
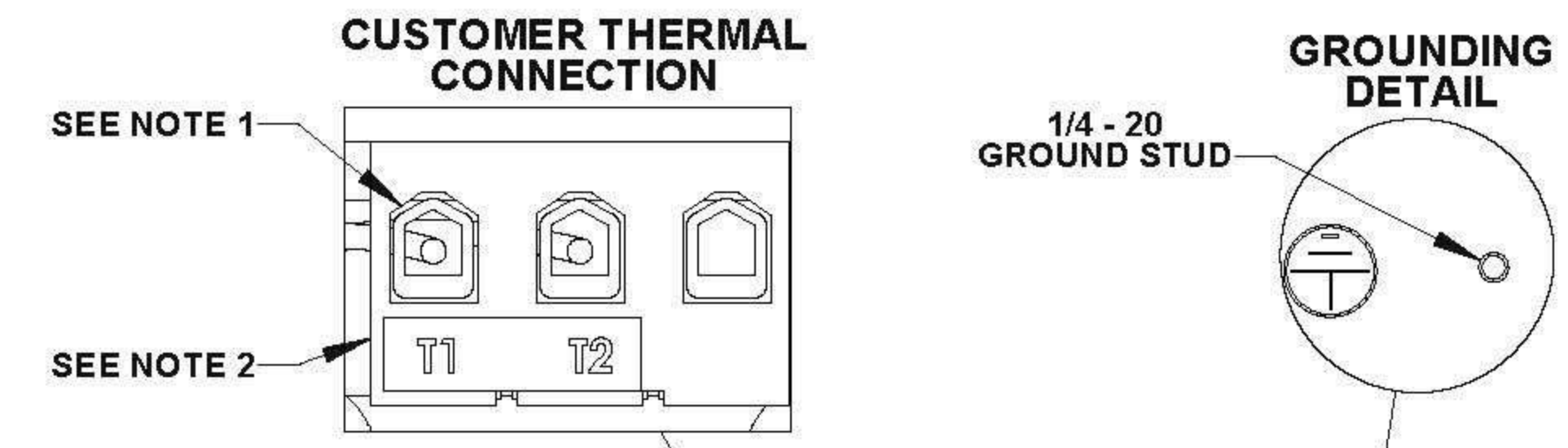
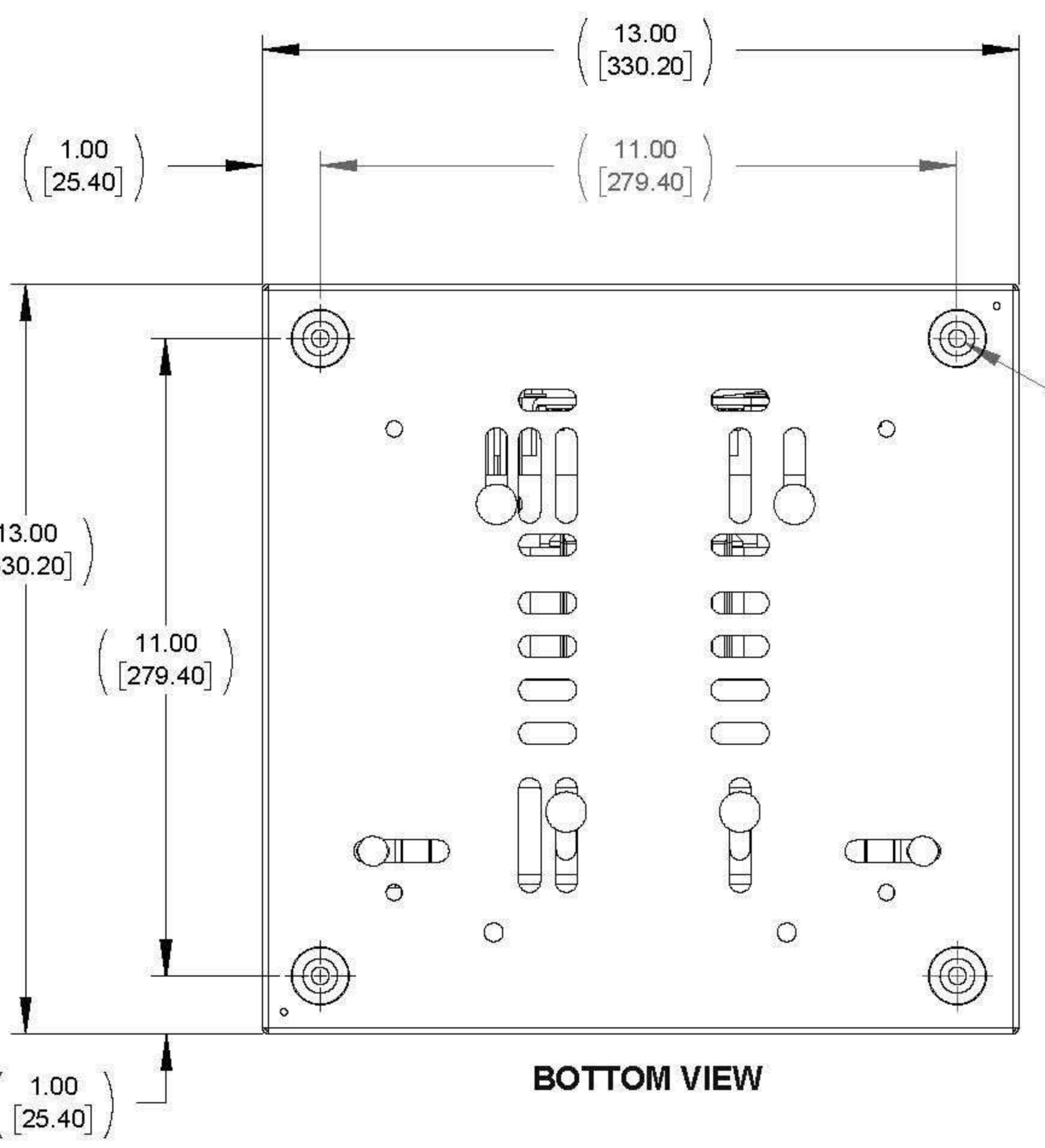
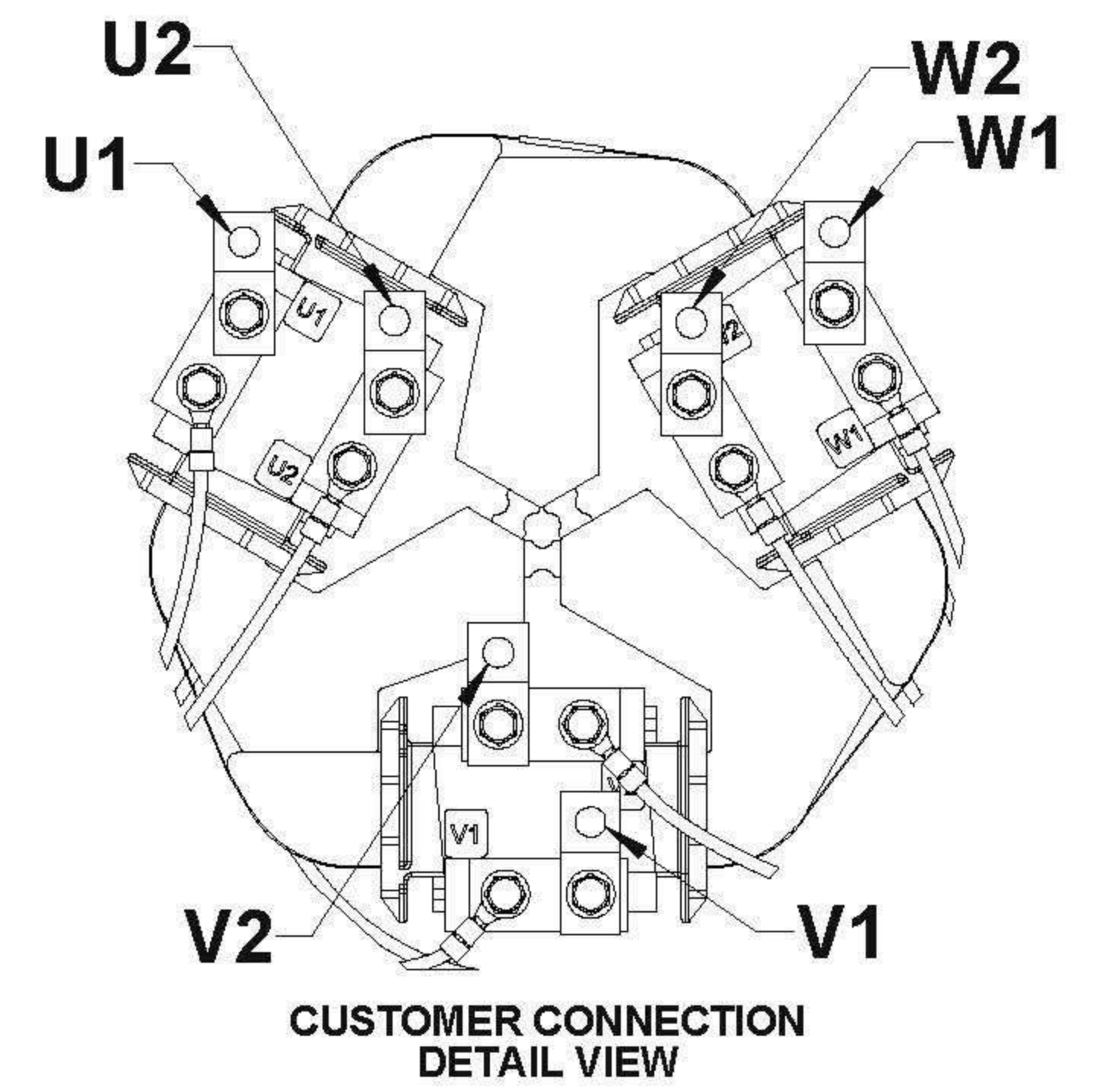
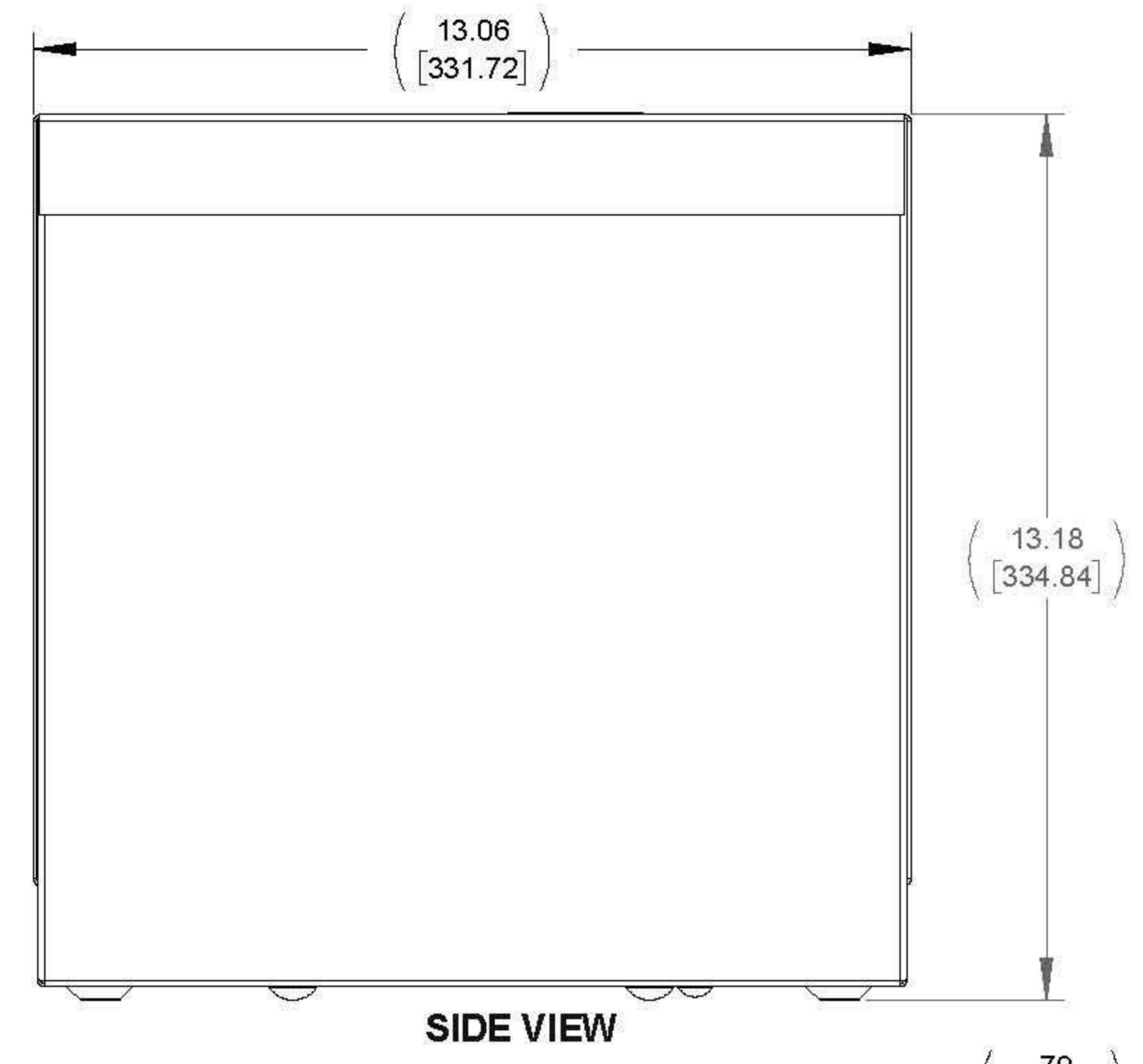
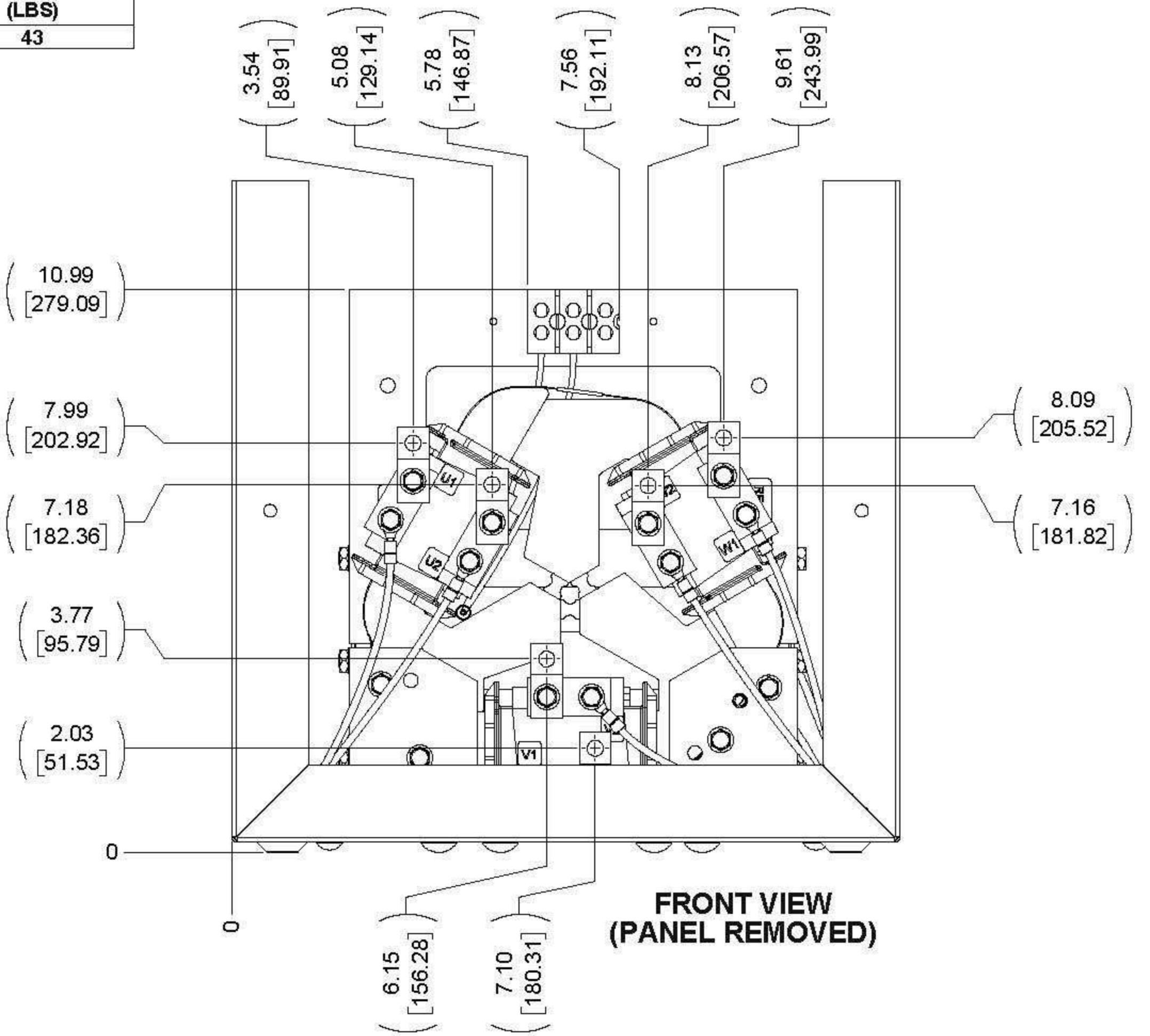

- NOTES:**
1. WIRE RANGE: 4 - 18 AWG.
 2. TERMINAL SCREW TIGHTENING TORQUE: 16 IN/LBS
 3. WIRE RANGE: 1/0 - 14 AWG.
 4. TERMINAL SCREW TIGHTENING TORQUE: (1/0-3AWG) 50 IN/LBS, (4-6AWG) 45 IN/LBS, (8AWG) 40 IN/LBS, (10-14AWG) 35 IN/LBS

THE COMPONENT, PART OR ASSEMBLY DESCRIBED IN THIS DOCUMENT MUST COMPLY WITH THE EU (EUROPEAN UNION) DIRECTIVE RoHS2		MATERIAL		CONFIDENTIAL AND PROPRIETARY INFORMATION THIS DOCUMENT CONTAINS CONFIDENTIAL AND PROPRIETARY INFORMATION OF MTE CORPORATION AND MAY NOT BE USED, COPIED OR DISCLOSED TO OTHERS EXCEPT WITH THE AUTHORIZED WRITTEN PERMISSION OF MTE CORPORATION	
CONTAINS <0.1% OF ANY SVHC BY WEIGHT PER REACH REGULATION				DESCRIPTION	
UNLESS OTHERWISE SPECIFIED DIMENSIONS ARE IN INCHES (MM) TOLERANCES ARE:		DRAWN		DV SENTRY 80A 380-600V FILTER, NEMA 1/2 ENCL.	
ANGLES: ± 1°		DATE		SIZE	
1 PLACE .X: ± .1 [2.5]		06/12/14		D	
2 PLACE .XX: ± .03 [0.76]		CHECKED		DWG No.	
3 PLACE .XXX: ± .010 [0.254]		DATE		CD DVSG0080E	
		TM		REV	
		01/18/17		02	
		APPROVED		SCALE	
		DATE		1:2	
		TM		SHEET 1 OF 1	
		01/18/17			

