

Midi Industrial Relay Type RMI. 2-10 10A Monostable

CARLO GAVAZZI



RMI A 210

- High switching power
- Small size
- 2 poles configuration
- AC coils 6 to 230VAC
- DC coils 5 to 110VDC
- Matched sockets available
- Standard with LED, Push with arm and Flag
- IP 40
- Compliant with the CE low voltage directive
- TÜV, UL, CSA, IMQ approved

Product Description

The RMI relay (relay mini-industrial) can be used for a wide range of industrial applications.

Available in 2 change-over contact configuration. PCB, solder and plug-in terminals.

Approvals



Ordering Key

RMI A 210 12VDC /1

Type _____
 Terminal version _____
 Contact code _____
 Coil code _____
 Options _____

Terminal version: A = Soldering terminals
 B = PCB terminals

Box content: 25 relays
 Box size: (W 125 x D 165 x H 50) mm Weight: 850g
 (W 4.92 x D 6.50 x H 1.97) inches Weight: 29.98oz

Type Selection

Contact configuration	Contact rating	Contact code
2 change over contacts (DPDT {2-form C})	10A	210

Coil Characteristics, DC

Coil Code	Nominal voltage VDC	@ +20°C (+68°F)		Coil resistance Ω
		Pick-up voltage VDC	Drop-out voltage DVC	
5VDC	5	4.0	0.5	28.0 ±10%
6VDC	6	4.8	0.6	40.0 ±10%
12VDC	12	9.6	1.2	160.0 ±10%
24VDC	24	19.2	2.4	640.0 ±10%
48VDC	48	38.4	4.8	2560.0 ±15%
60VDC	60	48.0	6.0	4000.0 ±15%
110VDC	110	88.0	11.0	12250 ±15%



Coil Characteristics, AC

Coil Code	Nominal voltage VAC	@ +20°C (+68°F)		Coil resistance Ω
		Pick-up voltage VAC	Drop-out voltage VAC	
6VAC	6	4.8	1.8	11 ±10%
12VAC	12	9.6	3.6	44 ±10%
24VAC	24	19.2	7.2	177 ±10%
48VAC	48	38.4	14.4	708 ±10%
115/120VAC	110-120	96.0	36.0	4080 ±15%
230VAC	220-240	176.0	66.0	16300 ±15%

Options

Nil = Standard with Push Arm -LED (A1+) (A2-)- Flag
/0 = Diode against polarity reverse + free-wheeling Diode (A1+) (A2-)
/1 = Without LED
/2 = Without Flag
/3 = Without Push Arm
/4 = Plated Contacts Au > 5µm
/5 = Flash Gilded Contacts Au > 1µm
/6 = Free-Wheeling Diode (A1+) (A2-)
/7 = Free-Wheeling Diode (A1-) (A2+)

Contact Characteristics

Contact rating (with resistive load)	10A - 250VAC / 30VDC	Minimum Current Min. applicable load /4 and /5 versions	5mA @ 12VDC 1mA @ 6VDC
UL rating	10A - 250VAC / 30VDC 1/3HP @ 240VAC	Max. switch. voltage	250VAC / 30VDC @ 10A
Max. rating	10A - 250VAC / 30VDC	Max. switch. power	2500VA / 300W @ 10A
Material	AgCe	Life Electrical life Mechanical life	1x10⁵ cycles (1800 Ops/h) 2x10⁷ cycles (1800 Ops/h)
Initial contact resistance	50mΩ (@ 1A 6VDC)		

Insulation

Dielectric strength (1min.) Between coil and contacts Between open contacts Contact/Contact	1500 VAC 1000 VAC 1500 VAC	Insulation according to EN61810-5 Rated insulation voltage Impulsive insulation voltage Pollution degree Overvoltage category	250V 3.6kV 2 III
Insulation resistance	1.000MΩ - 500VAC		

General Data

Nominal coil power	DC0.9~1.1W/AC0.9~1.4VA	Shock resistance Functional Destructive	100m/s² /10g 11ms 1000m/s² /100g
Operating time (At nominal voltage)	20ms max.	Humidity	35% to 95% RH non-condensing
Release time (At nominal voltage)	20ms max.	Terminals	PCB or Soldering Lugs (Plug-in)
Ambient temperature	-55° to +70°C (-67° to +158°F)	Weight	~37g (~1.30oz)
Vibration resistance	10 to 55Hz 1.0mm (0.04")		
Construction	Dust cover		

Wiring Diagram

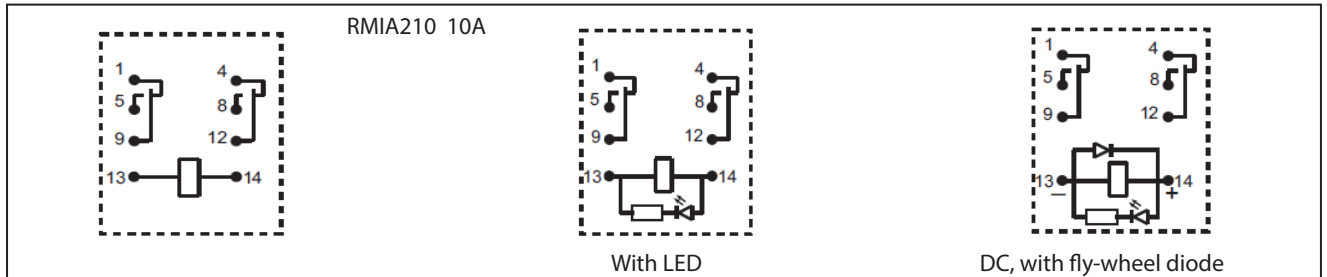

Dimensions mm/inches

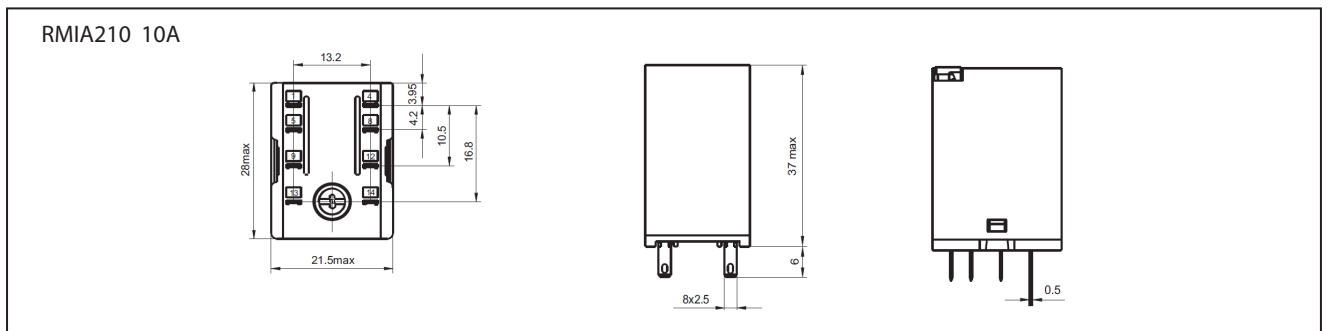

Diagrams

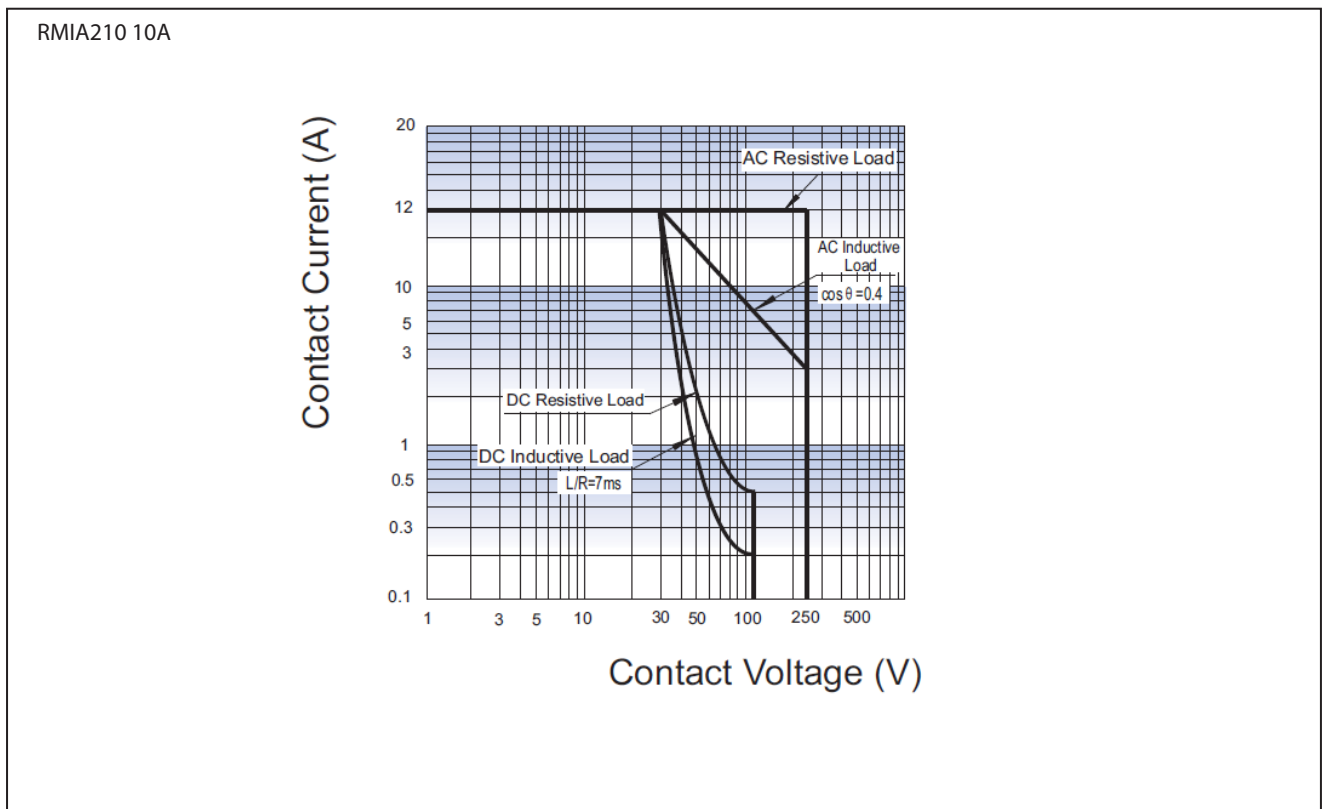

Bases and Sockets

DIN rail sockets codes are **ZMI2NA**, **ZMI4NA**, **ZMI2SA**, **ZMI4SA**, **ZMI2GA**, **ZMI4GA**, **ZR08** and **ZDM14A** details and specifications from page 45 to 49 of industrial relays catalogue.

PCB sockets codes are **ZC15/2A**, **ZC15/4A**, **ZC15/2** and **ZC15/4** details and specifications on page 51 of industrial relays catalogue.

Specifications are subject to change without notice. Pictures are just an example. For special features and/or customization, please ask to our sales network.

Midi Industrial Relay Type RMI. 4-5 5A Monostable

CARLO GAVAZZI



RMI A 45

- High switching power
- Small size
- 4 poles configuration
- AC coils 6 to 230VAC
- DC coils 5 to 110VDC
- Matched sockets available
- Standard with LED, Push with arm and Flag
- IP 40
- Complain with the CE low voltage directive
- TÜV, UL, CSA, IMQ approved

Product Description

The RMI relay (relay mini-industrial) can be used for a wide range of industrial applications.

Available in 4 change-over contact configuration. PCB, solder and plug-in terminals.

Approvals



Ordering Key

RMI A 45 12VDC /1

Type _____
 Terminal version _____
 Contact code _____
 Coil code _____
 Options _____

Terminal version: A = Soldering terminals
 B = PCB terminals

Box content: 25 relays
 Box size: (W 125 x D 165 x H 50) mm Weight: 850g
 (W 4.92 x D 6.50 x H 1.97) inches Weight: 29.98oz

Type Selection

Contact configuration	Contact rating	Contact code
4 change over contacts (4PDT {4-form C})	5A	45

Coil Characteristics, DC

Coil Code	Nominal voltage VDC	@ +20°C (+68°F)		Coil resistance Ω
		Pick-up voltage VDC	Drop-out voltage VDC	
5VDC	5	4.0	0.5	28 ±10%
6VDC	6	4.8	0.6	40.0 ±10%
12VDC	12	9.6	1.2	160.0 ±10%
24VDC	24	19.2	2.4	640.0 ±10%
48VDC	48	38.4	4.8	2560.0 ±15%
60VDC	60	48.0	6.0	4000.0 ±15%
110VDC	110	88.0	11.0	12250.0 ±15%

Coil Characteristics, AC

Coil Code	Nominal voltage VAC	@ +20°C (+68°F)		Coil resistance Ω
		Pick-up voltage VAC	Drop-out voltage VAC	
6VAC	6	4.8	1.8	11 ±10%
12VAC	12	9.6	3.6	44 ±10%
24VAC	24	19.2	7.2	177 ±10%
48VAC	48	38.4	14.4	708 ±10%
115/120VAC	110-120	96.0	36.0	4080 ±15%
230VAC	220-240	176.0	66.0	16300 ±15%

Options

Nil = Standard with Push Arm -LED (A1+) (A2-)- Flag
 /0 = Diode against polarity reverse + free-wheeling Diode (A1+) (A2-)
 /1 = Without LED
 /2 = Without Flag
 /3 = Without Push Arm

/4 = Plated Contacts Au > 5µm
 /5 = Flash Gilded Contacts Au > 1µm
 /6 = Free-Wheeling Diode (A1+) (A2-)
 /7 = Free-Wheeling Diode (A1-) (A2+)

Contact Characteristics

Contact rating (with resistive load)	5A - 250VAC	Minimum Current Min. applicable load /4 and /5 versions	5mA @ 12VDC 1mA @ 6VDC
UL rating	5A - 250VAC/30VDC 1/6HP @ 240VAC	Initial contact resistance	50mΩ (@ 1A 6VDC)
Usually rating (1x10 ⁵ ops)	5A - 250VAC / 30VDC	Max. switch. voltage	250VAC / 30VDC @ 5A
Max. rating (5x10 ⁴ ops)	5A - 250VAC / 30VDC	Max. switch. power	1250VA / 150W @ 5A
Material	AgSn ₂ In ₂ O ₃	Life Electrical life Mechanical life	1x10 ⁵ cycles (1800 Ops/h) 1x10 ⁷ cycles (1800 Ops/h)

Insulation

Dielectric strength (1min.) Between coil and contacts Between open contacts Contact/Contact	1500VAC 1000VAC 1500VAC	Insulation according to EN61810-5 Rated insulation voltage Impulsive insulation voltage Pollution degree Overvoltage category	250V 2.2kV 2 II
Initial insulation resistance	1.000MΩ - 500VAC		

General Data

Nominal coil power	DC0.9~1.1W/AC0.9~1.4VA	Shock resistance Funktional Destructive	100m/s ² /10g 1000m/s ² /100g
Operating time (At nominal voltage)	25ms max.	Humidity	35% to 95% RH non-condensing
Release time (At nominal voltage)	25ms max.	Terminals	PCB or Soldering Lugs (Plug-in)
Ambient temperature	-55° to +70°C (-67° to +158°F)	Weight	~37g (~1.30oz)
Vibration resistance	10 to 55Hz 1.5mm (0.06")		
Construction	Dust cover		

Wiring Diagram

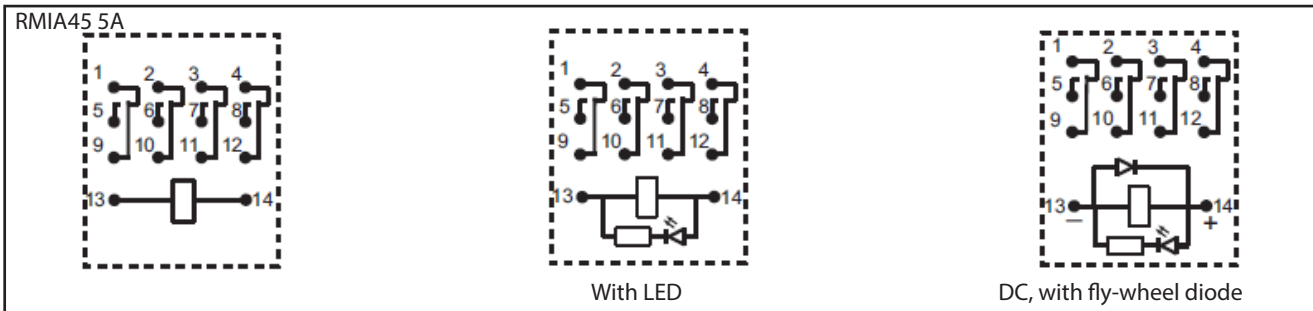

Dimensions mm/inches

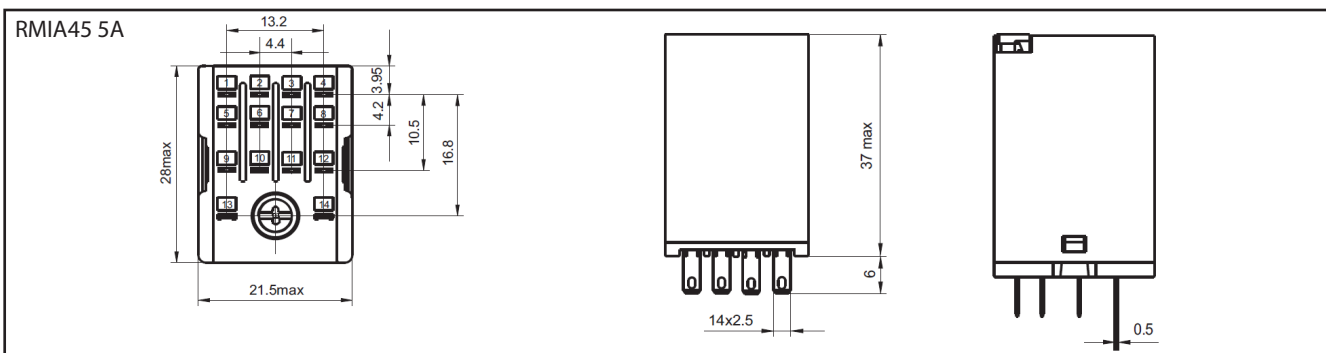

Diagrams

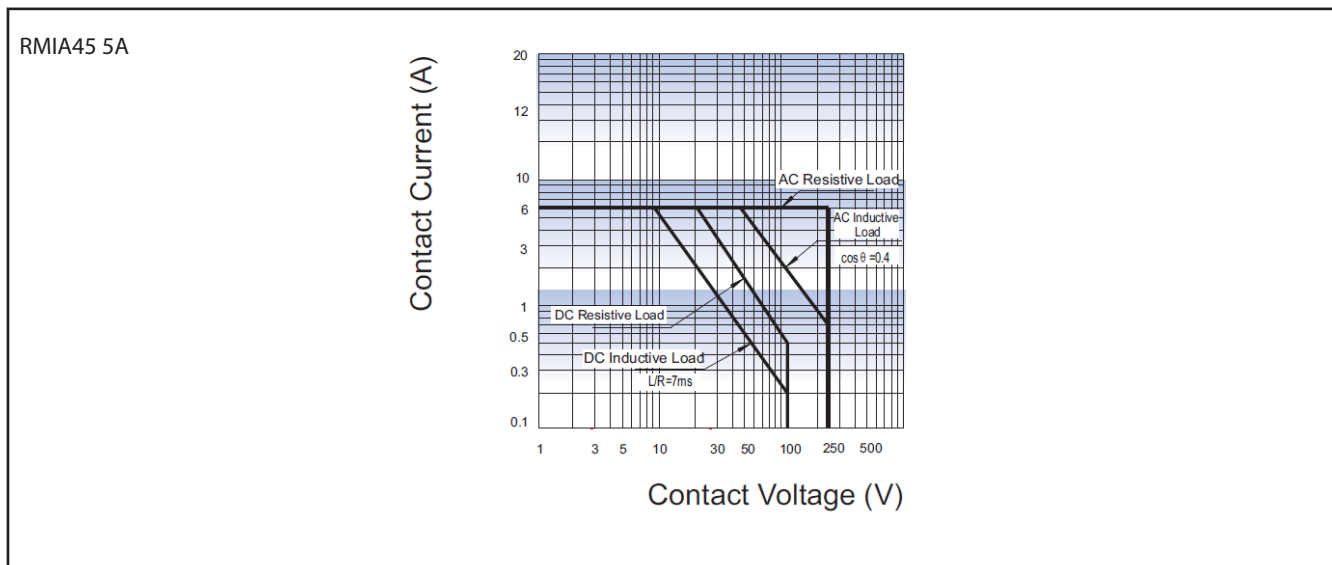

Bases and Sockets

DIN rail sockets codes are **ZMI4NA**, **ZMI4SA**, **ZMI4GA**, and **ZDM14A** details and specifications from page 45 to 49 of industrial relays catalogue.
 PCB sockets codes are **ZC15/4A** and **ZC15/4** details and specifications on page 51 of industrial relays catalogue.