

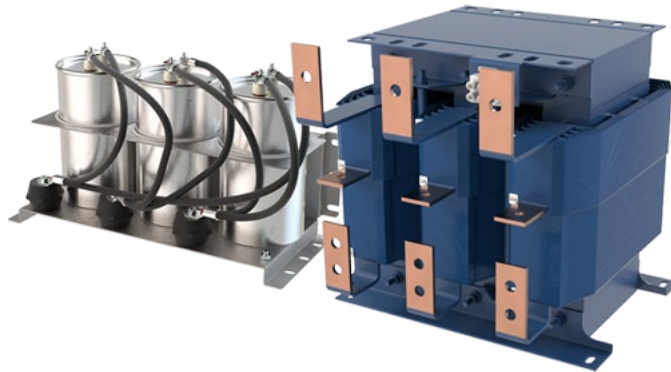

SineWave Guardian®

208V – 600V

TECHNICAL REFERENCE MANUAL



High Voltage! Only a qualified electrician can carry out the electrical installation of this filter.

Quick Reference

1	Performance Data	Pages 5 - 10
2	Selection Guide	Pages 11 – 22
3	Installation Guide	Pages 23 – 35
4	Start-up/Troubleshooting	Pages 36 – 40

This page intentionally left blank

TABLE OF CONTENTS

1. SAFETY	1
WARNINGS AND CAUTIONS.....	1
GENERAL SAFETY INSTRUCTIONS.....	2
2. GENERAL INFORMATION	3
RECEIPT & REPAIR STATEMENT	3
ENCLOSURES	4
AGENCY APPROVALS	4
WARRANTY.....	4
3. SINEWAVE GUARDIAN PERFORMANCE DATA	5
PERFORMANCE SPECIFICATIONS	5
FILTER EFFICIENCY + WATT LOSS, SINEWAVE GUARDIAN 208V-240V	6
FILTER EFFICIENCY + WATT LOSS, SINEWAVE GUARDIAN 380V-480V	7
FILTER EFFICIENCY + WATT LOSS, SINEWAVE GUARDIAN 600V	8
VOLTAGE WAVEFORMS	9
ALTITUDE DERATING.....	10
MOTOR FREQUENCY DERATING	10
4. HOW TO SELECT	11
SELECTION GUIDE	11
UNDERSTANDING THE SINEWAVE GUARDIAN PART NUMBER.....	12
SINEWAVE GUARDIAN 208V-240V, 60HZ SELECTION TABLES	13
SINEWAVE GUARDIAN 380V-480V, 60HZ SELECTION TABLES	16
SINEWAVE GUARDIAN 600V, 60HZ SELECTION TABLES.....	19
5. HOW TO INSTALL	23
INSTALLATION CHECKLIST	23
POWER WIRING CONNECTION	25
MODULAR UNIT INTERCONNECTION DIAGRAM	27
ENCLOSED UNIT INTERCONNECTION DIAGRAM.....	28
BASIC SCHEMATIC DIAGRAM	29
ISOLATION TRANSFORMER DIAGRAM	30
TORQUE RATINGS 208V-240V	31
TORQUE RATINGS 380V-480V	32
TORQUE RATINGS 600V	34
6. START-UP	36
STARTUP CHECKLIST	36
7. TROUBLESHOOTING	38
SINEWAVE GUARDIAN MOTOR PROTECTION FILTER FIELD CHECKS	39



List of Figures

Figure 3-1: Output Voltage before SineWave Guardian	9
Figure 3-2: Output Voltage after SineWave Guardian	9
Figure 3-3: Altitude Derating Curve	10
Figure 3-4: Motor Frequency Derating	10
Figure 5-1: Modular Interconnection	27
Figure 5-2: Enclosed Interconnection	28
Figure 5-3: Basic Schematic Diagram	29
Figure 5-4: Isolation Transformer.....	30



List of Tables

Table 3-1: Performance Specifications	5
Table 3-2: Filter Efficiency + Watt Loss SineWave Guardian 208V-240V, 60Hz.....	6
Table 3-3: Filter Efficiency + Watt Loss SineWave Guardian 380V-480V, 60Hz.....	7
Table 3-4: Filter Efficiency + Watt Loss SineWave Guardian 600v, 60Hz.....	8
Table 4-1: SineWave Guardian 208V-240V Open Panel.....	13
Table 4-2: SineWave Guardian 208V-240V Enclosed NEMA 1/2	14
Table 4-3: SineWave Guardian 208V-240V Enclosed NEMA 3R.....	15
Table 4-4: SineWave Guardian 380V-480V Open Panel.....	16
Table 4-5: SineWave Guardian 380V-480V Enclosed NEMA 1/2	17
Table 4-6: SineWave Guardian 380V-480V Enclosed NEMA 3R.....	18
Table 4-7: SineWave Guardian 600V Open Panel	19
Table 4-8: SineWave Guardian 600V Enclosed NEMA 1/2	21
Table 4-9: SineWave Guardian 600V Enclosed NEMA 3R	22
Table 5-1: Overtemperature Switch	24
Table 5-2: Torque Ratings 208V-240V	31
Table 5-3: Torque Ratings 380V-480V	32
Table 5-4: Torque Ratings 600V.....	34
Table 7-1: Troubleshooting Guide	40



1. SAFETY

Warnings and Cautions

The following symbols are used in this manual:

 WARNING	<p>High Voltage Warning: warns of situations that dangerously high voltage is involved. Failure to use proper precautions may lead to serious injury or death.</p>
 WARNING	<p>General Warning: warns of situations that can result in serious injury or death if proper precautions are not used.</p>
 Caution	<p>General Caution: identifies situations that could lead to malfunction or possible equipment damage.</p>

General Safety Instructions

 WARNING	<p>High Voltage! Only a qualified electrician can carry out the electrical installation of this filter.</p>
	<p>High voltage is used in the operation of this filter. Use extreme caution to avoid contact with high voltage when operating, installing or repairing this filter. Injury or death may result if safety precautions are not observed.</p>
 WARNING	<p>The opening of the branch circuit protective device may be an indication that a fault current has been interrupted. To reduce the risk of fire or electrical shock, current-carrying parts and other components of the filter should be examined and replaced if damaged.</p>
	<p>An upstream disconnect/protection device must be used as required by the National Electrical Code (NEC) or governing authority.</p>
	<p>Even if the upstream disconnect/protection device is open, the drive downstream of the filter may feed back high voltage to the filter. The drive safety instructions must be followed. Injury or death may result if safety precautions are not observed.</p>
	<p>The filter must be grounded with a grounding conductor connected to all grounding terminals. Modular filters must have reactor grounded through a 2"x2" area cleaned of paint and varnish on lower mounting bracket.</p>
	<p>Only spare parts obtained from MTE Corporation or an authorized MTE distributor can be used.</p>
 Caution	<p>Loose or improperly secured connections may damage or degrade filter performance. Visually inspect and secure all electrical connections before power is applied to the filter.</p>
	<p>Prior to start-up; confirm the drive operation mode is properly set. Please consult drive manual/manufacturer to configure proper parameters. Failure to do so may result in failure of drive or filter components.</p>

2. GENERAL INFORMATION

The purpose of this manual is to properly specify, size, and install the SineWave Guardian.

For most current information, please refer to website:

<http://www.mtecorp.com/products/sinewave-guardian/>

SineWave Guardian filters transform the output of Variable Frequency Drives (VFDs) to a near perfect sinusoidal waveform for the best level of motor protection. MTE's unique design offers high performance with smaller size and better efficiency than traditional LC filters.

Receipt & Repair Statement

Upon Receipt of this Filter:

The SineWave Guardian motor protection filter has been subjected to demanding factory tests before shipment. Carefully inspect the shipping container for damage that may have occurred in transit. Then unpack the filter and carefully inspect for any signs of damage. Save the shipping container for future transport of the filter.

In the event of damage, please contact and file a claim with the freight carrier involved immediately.

If the equipment is not going to be put into service upon receipt, cover and store the filter in a clean, dry location. After storage, ensure that the equipment is dry and that no condensation or dirt has accumulated on the internal components of the filter before applying power.

Repair/Exchange Procedure

MTE Corporation requires a Return Material Authorization Number and form before we can accept any filters that qualify for return or repair. If problems or questions arise during installation, setup, or operation of the filter, please contact MTE for assistance at:

Toll Free: 1-800-455-4MTE (1-800-455-4683)

International Tel: (+1) 262-253-8200

Fax: 262-253-8222

Enclosures

MTE enclosures are designed to provide a degree of protection for electrical components and prevent incidental personnel contact with the enclosed equipment. Depending on the enclosure selected, these enclosures meet the requirements of NEMA 1/2 or NEMA 3R.

An approximate cross reference guide between NEMA, UL, CSA and IEC enclosure follows.

Type 1 NEMA / IEC IP20 Enclosure:

Are designed for indoor use and will provide protection against contact with the enclosed equipment.

Type 2 NEMA / IEC IP20 Enclosure:

Are designed for indoor use and will provide protection against contact with the enclosed equipment and provide a degree of protection against limited amounts of falling water and dirt.

Type 3R NEMA / IEC IP21 Enclosure:

Are designed for outdoor use primarily to provide protection against contact with the enclosed equipment and provide a degree of protection against falling rain sleet and external ice formation.

Agency Approvals

UL and cUL listed to UL508 Type MX and CSA-C22.2 No 14-95
File E180243

Warranty

Three years from the date of shipment. See <http://www.mtecorp.com/industry-leading-warranty/> for details.

3. SineWave Guardian Performance Data

Performance Specifications

Table 3-1: Performance Specifications

Service Load Condition	Conventional 3 phase motors operating in volts per Hertz mode Standard step-up or delta-wye isolation transformer
Voltage	208V - 600V +/- 10%
Input Voltage Wave Form	PWM
Harmonic Voltage Distortion	5% maximum @ 2kHz
Inverter Switching Frequency	2kHz – 8kHz (Optimal performance achieved @ 2kHz)
Inverter Operating Frequency	6Hz to 75Hz, >75Hz to 120Hz with derating
Maximum Ambient Temperature	-40C to +60C Modular Filter -40C to +55C Enclosed Filter -40C to +90C Storage
Insulation System	Class N (200° C)
Insertion Loss (Voltage)	6% maximum @ 60Hz
Efficiency	>98%
Current range	2A – 1500A
Available form factors	Modular NEMA 1 & 2 NEMA 3R
Altitude without derating	3,300 feet above sea level
Maximum Motor Lead Length	15,000 feet
Relative Humidity	0% to 95% non-condensing
Current Rating	100% RMS Continuous 150% for 1 minute Intermittent
Audible Noise	75dB A at 1 meter

NOTE: Filter does not mitigate any DC bus ripple that may be present.

Filter Efficiency + Watt loss, SineWave Guardian 208V-240V

Table 3-2: Filter Efficiency + Watt Loss SineWave Guardian 208V-240V, 60Hz

Maximum Output Amps RMS/Filter Current Rating Amps RMS	Efficiency (%)	Typical Power Dissipation (Watts*)	Typical Capacitor Current (Amps RMS)
9	98.6%	63	2.3
12	98.9%	75	3
17	99.2%	101	4.3
22	99.3%	112	5.5
30	99.4%	100	7.5
45	99.4%	138	11.3
55	99.5%	162	13.8
70	99.5%	192	17.5
85	99.5%	201	21.3
110	99.6%	226	27.5
135	99.5%	299	33.8
160	99.6%	303	40
200	99.6%	387	50
250	99.6%	374	62.5
320	99.6%	637	80

*Based on a typical 240V, 60Hz output frequency, 2kHz carrier frequency at full load application.

Filter Efficiency + Watt loss, SineWave Guardian 380V-480V

Table 3-3: Filter Efficiency + Watt Loss SineWave Guardian 380V-480V, 60Hz

Maximum Output Amps RMS/Filter Current Rating Amps RMS	Efficiency (%)	Typical Power Dissipation (Watts*)	Typical Capacitor Current (Amps RMS)
2	98.5%	25	0.5
3	98.3%	45	0.8
5	98.4%	75	1.3
7	98.6%	91	1.8
9	98.6%	97	2.3
12	98.9%	127	3
17	99.2%	130	4.3
22	99.3%	135	5.5
27	99.4%	140	6.8
35	99.4%	210	8.8
45	99.4%	225	11.3
55	99.5%	301	13.8
65	99.5%	310	16.3
80	99.5%	387	20
110	99.6%	395	27.5
130	99.5%	420	32.5
160	99.6%	595	40
200	99.6%	650	50
250	99.6%	775	62.5
305	99.6%	945	76.3
365	99.6%	1,050	91.3
415	99.6%	1,137	103.8
515	99.7%	1,235	128.8
600	99.7%	2,225	150
720	99.7%	2,300	180
850	99.7%	2,556	212.5
1,000	99.7%	2,850	250
1,200	99.7%	3,000	300
1,500	99.7%	3,210	375

*Based on a typical 480V, 60Hz output frequency, 2kHz carrier frequency at full load application.

Filter Efficiency + Watt loss, SineWave Guardian 600V

Table 3-4: Filter Efficiency + Watt Loss SineWave Guardian 600v, 60Hz

Maximum Output Amps RMS/Filter Current Rating Amps RMS	Efficiency (%)	Typical Power Dissipation (Watts*)	Typical Capacitor Current (Amps RMS)
2	98.5%	30	0.5
3	98.3%	51	0.8
5	98.4%	77	1.3
7	98.6%	97	1.8
9	98.6%	124	2.3
12	98.9%	126	3
17	99.2%	133	4.3
22	99.3%	146	5.5
27	99.4%	156	6.8
35	99.4%	210	8.8
45	99.4%	251	11.3
55	99.5%	293	13.8
65	99.5%	302	16.3
80	99.5%	359	20
110	99.6%	449	27.5
130	99.5%	647	32.5
160	99.6%	660	40
200	99.6%	765	50
250	99.6%	939	62.5
305	99.6%	1194	76.3
365	99.6%	1,359	91.3
415	99.6%	1,599	103.8
515	99.7%	1,670	128.8
600	99.7%	1,734	150
720	99.7%	2,250	180
865	99.7%	2,860	212.5
1,000	99.7%	3,250	250
1,200	99.7%	3,546	300
1,500	99.7%	3,762	375

*Based on a typical 600V, 60Hz output frequency, 2kHz carrier frequency at full load application.

Voltage Waveforms

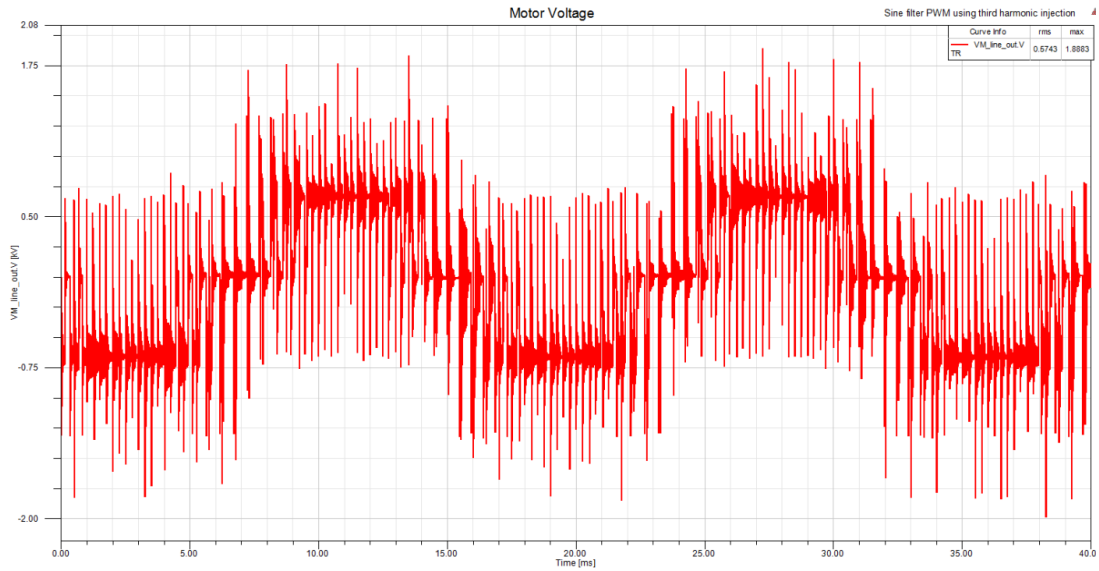

Figure 3-1 Output Voltage before SineWave Guardian

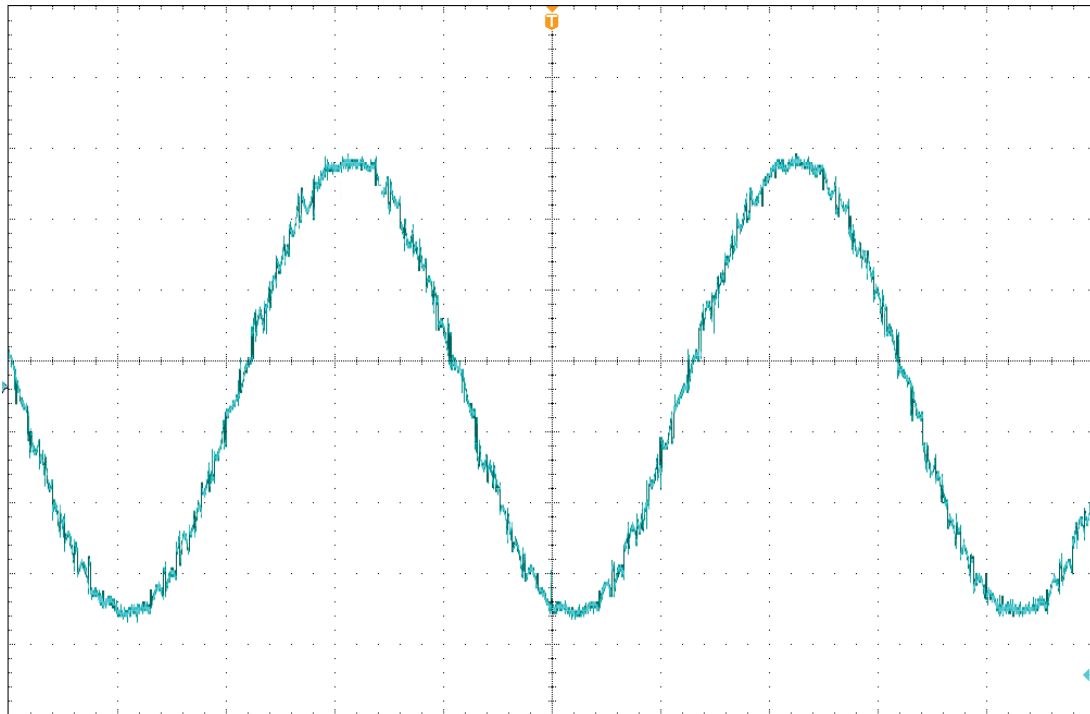

Figure 3-2: Output Voltage after SineWave Guardian

Altitude Derating

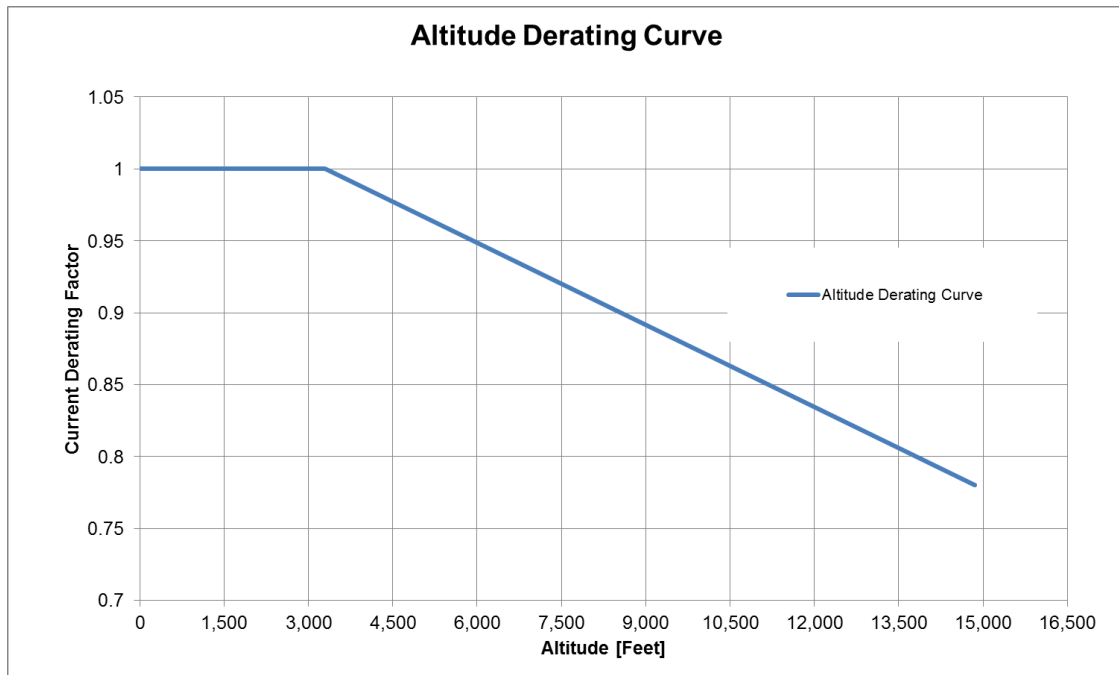

Figure 3-3: Altitude Derating Curve

Motor Frequency Derating

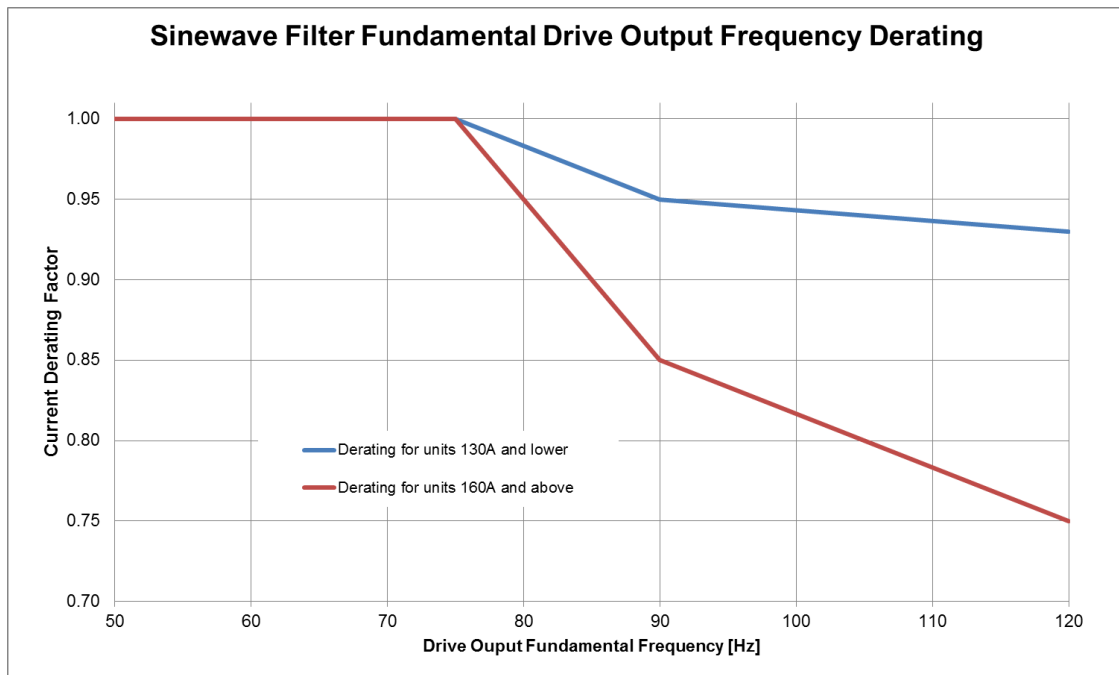

Figure 3-4: Motor Frequency Derating

4. HOW TO SELECT

Selection Guide

MTE's SineWave Guardian motor protection filters are designed to provide a sine wave output voltage when driven from PWM inverters with switching frequencies from 2 kHz to 8 kHz. For drive applications, these filters eliminate the problem of motor insulation failures and they also reduce electromagnetic interference by eliminating the high dV/dt associated with inverter output wave forms.

SineWave Guardian motor protection filters are available in Modular, NEMA 1/2, and NEMA 3R mechanical configurations.

NOTE: For inverters feeding isolation transformers select a filter with a current rating equal to or greater than that of the transformer primary current.

Please verify information below for proper selection:

- Lead Length:** This product is suitable for applications with motor leads up to 15,000 ft. Contact MTE Application Engineering for possible longer applications.
- Voltage:** Input voltage from 208V – 600V. See Table 3-1: Performance Specifications (p5) for specification.
- Current Rating:** 208V-240V 9 Amps – 320 Amps; 380V-600V 2 Amps – 1500 Amps.
- Switching Frequency:** Support for carrier frequency of 2kHz – 8kHz; see Table 3-1: Performance Specifications (p5). (Optimal performance achieved @ 2kHz)
- Drive Output Frequency:** Support for 6Hz to 75Hz without derating, >75Hz to 120Hz with derating. See Figure 3-4: Motor Frequency Derating (p10) for derating curve.
- Temperature:** Maximum ambient temperature, 60C (modular), 55C (enclosed). See Table 3-1: Performance Specifications (p5) for specification.
- Altitude:** 3,300 feet above sea level without derating, see Figure 3-3: Altitude Derating Curve (p10) for derating curve.
- Enclosure Type:** Modular, NEMA 1/2 & NEMA 3R, see Enclosures (p4) for enclosure descriptions.
- Confirm the drive operation mode is properly set based on the drive manual/manufacturer's recommendations.
- Refer to Article 430 Table 430.91 of the National Electrical code for the selection of the appropriate enclosure Type Number for your application.

Understanding the SineWave Guardian Part Number

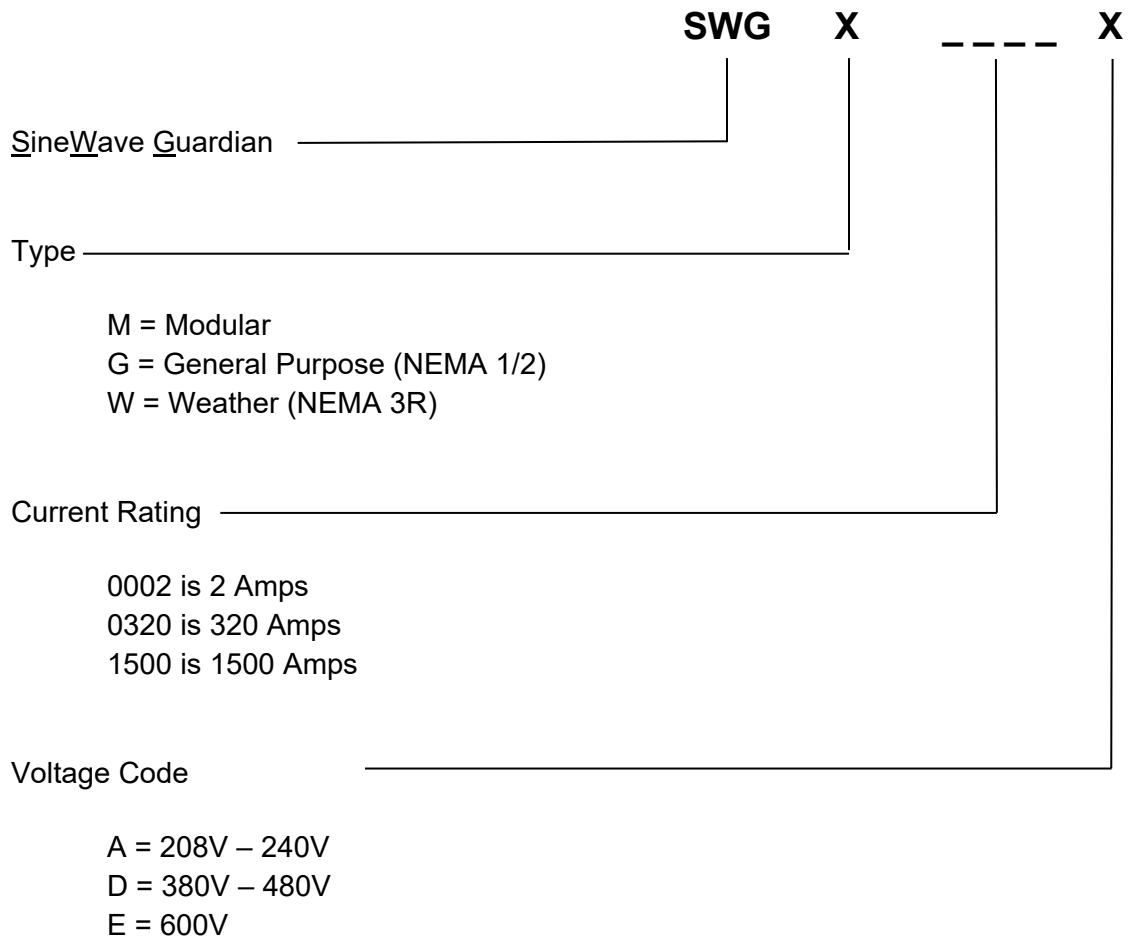

SineWave Guardian 208V-240V, 60Hz Selection Tables

Table 4-1: SineWave Guardian 208V-240V Open Panel

208V Motor HP	240V Motor HP	Filter Amp Rating	Part Number	App. Wt. (lbs.)	Open Magnetics (in.) (H x W x D)	3-Phase Capacitor (in.) (H x D) Capacitor Panel (in.) (H x W x D)
2	3	9	SWGM0009A	11	6.6 x 8.0 x 4.8	7.5 x 3.0
3	4	12	SWGM0012A	14	6.7 x 8.0 x 5.1	7.5 x 3.0
5	5.5	17	SWGM0017A	14	6.7 x 8.0 x 5.1	7.5 x 3.9
5.5	7.5	22	SWGM0022A	15	6.6 x 8.0 x 5.4	8.3 x 3.0
7.5	10	30	SWGM0030A	18	7.5 x 9.0 x 4.8	8.3 x 3.9
10 - 12.5	15	45	SWGM0045A	28	8.7 x 10.5 x 6.7	8.3 x 4.6
15	20	55	SWGM0055A	32	9.0 x 10.5 x 7.4	8.3 x 4.6
20	25	70	SWGM0070A	34	9.0 x 10.5 x 7.9	8.3 x 3.0
25	30	85	SWGM0085A	38	8.7 x 10.5 x 7.2	8.3 x 3.0
30	40	110	SWGM0110A	53	8.7 x 10.5 x 8.9	8.3 x 4.0
40	50	135	SWGM0135A	72	11.0 x 12.0 x 9.3	8.3 x 3.0
50	60	160	SWGM0160A	74	10.6 x 12.0 x 9.7	8.3 x 4.6
60	75	200	SWGM0200A	120	10.9 x 12.0 x 11.4	8.3 x 4.0
75	100	250	SWGM0250A	110	10.5 x 12.0 x 11.2	8.3 x 3.0 8.3 x 4.6
100	125	320	SWGM0320A	153	14.2 x 15.3 x 11.8	7.4 x 16.4 x 7.6

SineWave Guardian 208V-240V, 60Hz Selection Tables

Table 4-2: SineWave Guardian 208V-240V Enclosed NEMA 1/2

208V Motor HP	240V Motor HP	Filter Amp Rating	Part Number	App. Wt. (lbs.)	NEMA 1/2 Enclosure (in.) (H x W x D)
2	3	9	SWGG0009A	28	13.2 x 13.0 x 13.1
3	4	12	SWGG0012A	30	13.2 x 13.0 x 13.1
5	5.5	17	SWGG0017A	30	13.2 x 13.0 x 13.1
5.5	7.5	22	SWGG0022A	32	13.2 x 13.0 x 13.1
7.5	10	30	SWGG0030A	34	13.2 x 13.0 x 13.1
10 - 12.5	15	45	SWGG0045A	78	24.0 x 17.0 x 18.5
15	20	55	SWGG0055A	80	24.0 x 17.0 x 18.5
20	25	70	SWGG0070A	82	24.0 x 17.0 x 18.5
25	30	85	SWGG0085A	86	24.0 x 17.0 x 18.5
30	40	110	SWGG0110A	101	24.0 x 17.0 x 18.5
40	50	135	SWGG0135A	148	33.9 x 18.3 x 20.9
50	60	160	SWGG0160A	150	33.9 x 18.3 x 20.9
60	75	200	SWGG0200A	199	33.9 x 18.3 x 20.9
75	100	250	SWGG0250A	189	33.9 x 18.3 x 20.9
100	125	320	SWGG0320A	321	51.3 x 27.7 x 24.9

SineWave Guardian 208V-240V, 60Hz Selection Tables

Table 4-3: SineWave Guardian 208V-240V Enclosed NEMA 3R

208V Motor HP	240V Motor HP	Filter Amp Rating	Part Number	App. Wt. (lbs.)	NEMA 3R Enclosure (in.) (H x W x D)
2	3	9	SWG0009A	69	24.0 x 12.5 x 22.9
3	4	12	SWG0012A	69	24.0 x 12.5 x 22.9
5	5.5	17	SWG0017A	69	24.0 x 12.5 x 22.9
5.5	7.5	22	SWG0022A	71	24.0 x 12.5 x 22.9
7.5	10	30	SWG0030A	73	24.0 x 12.5 x 22.9
10 - 12.5	15	45	SWG0045A	85	24.0 x 12.5 x 22.9
15	20	55	SWG0055A	87	24.0 x 12.5 x 22.9
20	25	70	SWG0070A	90	24.0 x 12.5 x 22.9
25	30	85	SWG0085A	93	24.0 x 12.5 x 22.9
30	40	110	SWG0110A	109	24.0 x 12.5 x 22.9
40	50	135	SWG0135A	159	33.9 x 18.3 x 26.0
50	60	160	SWG0160A	161	33.9 x 18.3 x 26.0
60	75	200	SWG0200A	209	33.9 x 18.3 x 26.0
75	100	250	SWG0250A	199	33.9 x 18.3 x 26.0
100	125	320	SWG0320A	334	51.3 x 27.7 x 30.0

SineWave Guardian 380V-480V, 60Hz Selection Tables

Table 4-4: SineWave Guardian 380V-480V Open Panel

380V Motor KW	480V Motor HP	Filter Amp Rating	Part Number	App. Wt. (lbs.)	Open Magnetics (in.) (H x W x D)	3-Phase Capacitor (in.) (H x D) Capacitor Panel (in.) (H x W x D)
0.5	0.75	2	SWGM0002D	6	4.5 x 4.4 x 2.6	7.5 x 2.9
0.75	1.5	3	SWGM0003D	8	4.5 x 4.4 x 3.3	7.5 x 2.9
2.2	3	5	SWGM0005D	12	6.7 x 8.0 x 4.8	7.5 x 2.9
3	4	7	SWGM0007D	13	6.7 x 8.0 x 5.1	7.5 x 2.9
4	5.5	9	SWGM0009D	15	6.7 x 8.0 x 5.1	7.5 x 2.9
5.5	7.5	12	SWGM0012D	17	6.7 x 8.0 x 5.4	7.5 x 2.9
7.5	10	17	SWGM0017D	20	7.5 x 9.0 x 4.8	7.5 x 2.9
11	15	22	SWGM0022D	32	8.7 x 10.5 x 6.7	7.5 x 2.9
-	20	27	SWGM0027D	35	8.7 x 10.5 x 6.7	7.5 x 2.9
18.5	25	35	SWGM0035D	39	8.9 x 10.5 x 6.7	7.5 x 3.9
22	30	45	SWGM0045D	43	8.8 x 10.5 x 7.2	7.5 x 3.9
-	40	55	SWGM0055D	54	8.8 x 10.5 x 8.2	8.3 x 3.9
30	50	65	SWGM0065D	64	10.8 x 12.0 x 8.6	8.3 x 4.9
37	60	80	SWGM0080D	75	10.8 x 12.0 x 9.0	8.3 x 4.9
55	75	110	SWGM0110D	105	10.7 x 12.0 x 10.5	8.3 x 4.9
-	100	130	SWGM0130D	110	10.7 x 12.0 x 11.5	8.3 x 4.9
75	125	160	SWGM0160D	160	14.5 x 15.3 x 11.3	6.9 x 16.4 x 7.6
110	150	200	SWGM0200D	168	14.5 x 15.3 x 11.8	6.9 x 16.4 x 7.6
132	200	250	SWGM0250D	228	14.5 x 15.3 x 13.8	6.9 x 16.4 x 7.6
160	250	305	SWGM0305D	261	14.6 x 15.3 x 14.9	6.9 x 16.4 x 7.6
200	300	365	SWGM0365D	310	14.6 x 15.3 x 15.2	6.9 x 16.4 x 7.6
220	350	415	SWGM0415D	326	14.6 x 15.3 x 15.2	6.9 x 16.4 x 7.6
280	450	515	SWGM0515D	356	15.0 x 15.3 x 16.2	10.7 x 16.4 x 7.6
335	500	600	SWGM0600D	479	18.3 x 24.0 x 14.6	7.9 x 16.4 x 7.6
375	600	720	SWGM0720D	711	18.2 x 24.0 x 14.6	6.9 x 16.4 x 7.6 7.9 x 16.4 x 7.6
450	700	850	SWGM0850D	835	18.2 x 24.0 x 19.0	(1) 6.9 x 16.4 x 7.6 (2) 8.9 x 16.4 x 7.6
560	850	1,000	SWGM1000D	942	18.1 x 24.0 x 20.6	(1) 6.9 x 16.4 x 7.6 (2) 10.7 x 16.4 x 7.6
675	1000	1,200	SWGM1200D	1,272	25.7 x 24.0 x 20.3	(3) 7.9 x 16.4 x 7.6
800	1200	1,500	SWGM1500D	1,293	25.9 x 24.0 x 20.0	(3) 10.7 x 16.4 x 7.6

SineWave Guardian 380V-480V, 60Hz Selection Tables

Table 4-5: SineWave Guardian 380V-480V Enclosed NEMA 1/2

380V Motor KW	480V Motor HP	Filter Amp Rating	Part Number	App. Wt. (lbs.)	NEMA 1/2 Enclosure (in.) (H x W x D)
0.55	0.75	2	SWGG0002D	20	13.2 x 13.0 x 13.1
0.75	1.5	3	SWGG0003D	21	13.2 x 13.0 x 13.1
2.2	3	5	SWGG0005D	25	13.2 x 13.0 x 13.1
3	4	7	SWGG0007D	27	13.2 x 13.0 x 13.1
4	5.5	9	SWGG0009D	29	13.2 x 13.0 x 13.1
5.5	7.5	12	SWGG0012D	29	13.2 x 13.0 x 13.1
7.5	10	17	SWGG0017D	34	13.2 x 13.0 x 13.1
11	15	22	SWGG0022D	79	24.0 x 17.1 x 18.5
-	20	27	SWGG0027D	82	24.0 x 17.1 x 18.5
18.5	25	35	SWGG0035D	86	24.0 x 17.1 x 18.5
22	30	45	SWGG0045D	90	24.0 x 17.1 x 18.5
-	40	55	SWGG0055D	101	24.0 x 17.1 x 18.5
30	50	65	SWGG0065D	136	33.9 x 18.3 x 20.9
37	60	80	SWGG0080D	147	33.9 x 18.3 x 20.9
55	75	110	SWGG0110D	179	33.9 x 18.3 x 20.9
-	100	130	SWGG0130D	182	33.9 x 18.3 x 20.9
75	125	160	SWGG0160D	327	51.3 x 27.7 x 24.9
110	150	200	SWGG0200D	337	51.3 x 27.7 x 24.9
132	200	250	SWGG0250D	395	51.3 x 27.7 x 24.9
160	250	305	SWGG0305D	431	51.3 x 27.7 x 24.9
200	300	365	SWGG0365D	480	51.3 x 27.7 x 24.9
220	350	415	SWGG0415D	496	51.3 x 27.7 x 24.9
280	450	515	SWGG0515D	764	87.6 x 43.7 x 31.1
335	500	600	SWGG0600D	891	87.6 x 43.7 x 31.1
375	600	720	SWGG0720D	1,127	87.6 x 43.7 x 31.1
450	700	850	SWGG0850D	1,473	84.0 x 52.0 x 36.5
560	850	1000	SWGG1000D	1,580	84.0 x 52.0 x 36.5
675	1000	1200	SWGG1200D	1,921	84.0 x 52.0 x 36.5
800	1200	1500	SWGG1500D	1,942	84.0 x 52.0 x 36.5

SineWave Guardian 380V-480V, 60Hz Selection Tables

Table 4-6: SineWave Guardian 380V-480V Enclosed NEMA 3R

380V Motor KW	480V Motor HP	Filter Amp Rating	Part Number	App. Wt. (lbs.)	NEMA 3R Enclosure (in.) (H x W x D)
0.55	0.75	2	SWG0002D	62	24.0 x 12.5 x 22.9
0.75	1.5	3	SWG0003D	64	24.0 x 12.5 x 22.9
2.2	3	5	SWG0005D	68	24.0 x 12.5 x 22.9
3	4	7	SWG0007D	69	24.0 x 12.5 x 22.9
4	5.5	9	SWG0009D	70	24.0 x 12.5 x 22.9
5.5	7.5	12	SWG0012D	72	24.0 x 12.5 x 22.9
7.5	10	17	SWG0017D	75	24.0 x 12.5 x 22.9
11	15	22	SWG0022D	87	24.0 x 12.5 x 22.9
-	20	27	SWG0027D	90	24.0 x 12.5 x 22.9
18.5	25	35	SWG0035D	94	24.0 x 12.5 x 22.9
22	30	45	SWG0045D	98	24.0 x 12.5 x 22.9
-	40	55	SWG0055D	108	24.0 x 12.5 x 22.9
30	50	65	SWG0065D	143	33.9 x 18.3 x 26.0
37	60	80	SWG0080D	161	33.9 x 18.3 x 26.0
55	75	110	SWG0110D	187	33.9 x 18.3 x 26.0
-	100	130	SWG0130D	195	33.9 x 18.3 x 26.0
75	125	160	SWG0160D	340	51.3 x 27.7 x 30.0
110	150	200	SWG0200D	350	51.3 x 27.7 x 30.0
132	200	250	SWG0250D	407	51.3 x 27.7 x 30.0
160	250	305	SWG0305D	444	51.3 x 27.7 x 30.0
200	300	365	SWG0365D	493	51.3 x 27.7 x 30.0
220	350	415	SWG0415D	509	51.3 x 27.7 x 30.0
280	450	515	SWG0515D	809	87.6 x 43.7 x 40.1
335	500	600	SWG0600D	936	87.6 x 43.7 x 40.1
375	600	720	SWG0720D	1,172	87.6 x 43.7 x 40.1
450	700	850	SWG0850D	1,514	84.0 x 52.0 x 45.5
560	850	1000	SWG1000D	1,621	84.0 x 52.0 x 45.5
675	1000	1200	SWG1200D	1,961	84.0 x 52.0 x 45.5
800	1200	1500	SWG1500D	1,983	84.0 x 52.0 x 45.5

SineWave Guardian 600V, 60Hz Selection Tables

Table 4-7: SineWave Guardian 600V Open Panel

600V Motor KW	600V Motor HP	Filter Amp Rating	Part Number	App. Wt. (lbs.)	Open Magnetics (in.) (H x W x D)	3-Phase Capacitor (in.) (H x D) Capacitor Panel (in.) (H x W x D)
0.75	1	2	SWGM0002E	8	4.9 X 4.4 X 3.0	7.9 X 3.0
1.5	2	3	SWGM0003E	11	6.7 X 8.0 X 4.8	7.9 X 3.0
3	3	5	SWGM0005E	14	6.6 X 8.0 X 5.1	7.9 X 3.0
3.7	5	7	SWGM0007E	15	6.7 X 8.0 X 5.4	7.9 X 3.0
5.5	7.5	9	SWGM0009E	17	6.7 X 8.0 X 4.3	7.9 X 3.0
7.5	10	12	SWGM0012E	20	7.5 X 9.0 X 4.8	7.9 X 3.0
11	15	17	SWGM0017E	26	7.5 X 9.0 X 5.3	7.9 X 3.0
15	20	22	SWGM0022E	34	8.7 X 10.5 X 6.7	7.9 X 3.0
18.5	25	27	SWGM0027E	40	8.7 X 10.5 X 7.7	7.9 X 3.0
22	30	35	SWGM0035E	40	8.7 X 10.5 X 7.7	7.9 X 3.0
30	40	45	SWGM0045E	53	8.7 X 10.5 X 8.7	7.9 X 3.0
37	50	55	SWGM0055E	63	10.7 X 12.0 X 9.4	7.9 X 3.0
45	60	65	SWGM0065E	78	10.7 X 12.0 X 9.7	7.9 X 3.0
55	75	80	SWGM0080E	92	10.7 X 12.0 X 10.1	7.9 X 3.0
75	100	110	SWGM0110E	106	10.7 X 12.0 X 10.5	7.9 X 3.0
90	125	130	SWGM0130E	161	14.4 X 15.3 X 11.2	7.9 X 3.0
110	150	160	SWGM0160E	195	12.5 X 15.3 X 14.2	7.9 X 3.0
150	200	200	SWGM0200E	245	14.6 X 15.3 X 14.7	9.9 X 16.4 X 7.6
185	250	250	SWGM0250E	282	14.6 X 15.3 X 15.7	12.7 X 16.4 X 7.6
220	300	305	SWGM0305E	333	15.1 X 15.3 X 15.6	(1) 12.7 X 16.4 X 7.6 (1) 8.9 X 16.4 X 7.6
250	350	365	SWGM0365E	327	15.1 X 15.3 X 15.6	(1) 12.7 X 16.4 X 7.6 (1) 8.9 X 16.4 X 7.6
335	450	415	SWGM0415E	360	14.8 X 15.3 X 16.6	(1) 12.7 X 16.4 X 7.6 (1) 8.9 X 16.4 X 7.6
375	500	515	SWGM0515E	507	18.2 X 24.0 X 14.5	(1) 12.7 X 16.4 X 7.6 (1) 9.9 X 16.4 X 7.6
450	600	600	SWGM0600E	726	17.9 X 24.0 X 17.4	(2) 12.7 X 16.4 X 7.6 (1) 8.9 X 16.4 X 7.6



600V Motor KW	600V Motor HP	Filter Amp Rating	Part Number	App. Wt. (lbs.)	Open Magnetics (in.) (H x W x D)	3-Phase Capacitor (in.) (H x D) Capacitor Panel (in.) (H x W x D)
525	700	720	SWGM0720E	854	18.1 X 24.0 X 18.9	(2) 12.7 X 16.4 X 7.6 (1) 9.9 X 16.4 X 7.6 (1) 7.9 X 3.0
675	900	865	SWGM0865E	895	18.3 X 24.0 X 19.1	(2) 12.7 X 16.4 X 7.6 (2) 9.9 X 16.4 X 7.6
750	1000	1000	SWGM1000E	877	18.1 X 24.0 x 20.0	(2) 12.7 X 16.4 X 7.6 (2) 9.9 X 16.4 X 7.6
935	1250	1200	SWGM1200E	1341	25.9 X 24.0 X 20.2	(4) 12.7 X 16.4 X 7.6 (1) 7.9 X 3.0
1100	1500	1500	SWGM1500E	1897	33.2 X 36.0 X 29.3	(5) 12.7 X 16.4 X 7.6 (1) 7.9 X 3.0

SineWave Guardian 600V, 60Hz Selection Tables

Table 4-8: SineWave Guardian 600V Enclosed NEMA 1/2

600V Motor KW	600V Motor HP	Filter Amp Rating	Part Number	App. Wt. (lbs.)	NEMA 1/2 Enclosure (in.) (H x W x D)
0.75	1	2	SWGG0002E	22	13.2 X 13.1 X 13.1
1.5	2	3	SWGG0003E	25	13.2 X 13.1 X 13.1
3	3	5	SWGG0005E	28	13.2 X 13.1 X 13.1
3.7	5	7	SWGG0007E	29	13.2 X 13.1 X 13.1
5.5	7.5	9	SWGG0009E	32	13.2 X 13.1 X 13.1
7.5	10	12	SWGG0012E	35	13.2 X 13.1 X 13.1
11	15	17	SWGG0017E	40	13.2 X 13.1 X 13.1
15	20	22	SWGG0022E	82	24.0 X 17.1 X 18.5
18.5	25	27	SWGG0027E	88	24.0 X 17.1 X 18.5
22	30	35	SWGG0035E	88	24.0 X 17.1 X 18.5
30	40	45	SWGG0045E	101	24.0 X 17.1 X 18.5
37	50	55	SWGG0055E	149	33.9 X 18.3 X 20.9
45	60	65	SWGG0065E	152	33.9 X 18.3 X 20.9
55	75	80	SWGG0080E	166	33.9 X 18.3 X 20.9
75	100	110	SWGG0110E	181	33.9 X 18.3 X 20.9
90	125	130	SWGG0130E	332	51.3 X 27.7 X 25.0
110	150	160	SWGG0160E	367	51.3 X 27.7 X 25.0
150	200	200	SWGG0200E	414	51.3 X 27.7 X 25.0
185	250	250	SWGG0250E	699	87.6 X 43.7 X 31.1
220	300	305	SWGG0305E	758	87.6 X 43.7 X 31.1
250	350	365	SWGG0365E	752	87.6 X 43.7 X 31.1
335	450	415	SWGG0415E	785	87.6 X 43.7 X 31.1
375	500	515	SWGG0515E	917	87.6 X 43.7 X 31.1
450	600	600	SWGG0600E	1,142	87.6 X 43.7 X 31.1
525	700	720	SWGG0720E	1,470	84.0 X 52.0 X 36.5
675	900	865	SWGG0865E	1,512	84.0 X 52.0 X 36.5
750	1000	1000	SWGG1000E	1,495	84.0 X 52.0 X 36.5
935	1250	1200	SWGG1200E	1,977	84.0 X 52.0 X 36.5



SineWave Guardian 600V, 60Hz Selection Tables

Table 4-9: SineWave Guardian 600V Enclosed NEMA 3R

600V Motor KW	600V Motor HP	Filter Amp Rating	Part Number	App. Wt. (lbs.)	NEMA 3R Enclosure (in.) (H x W x D)
0.75	1	2	SWG0002E	65	24.0 X 12.5 X 23.0
1.5	2	3	SWG0003E	68	24.0 X 12.5 X 23.0
3	3	5	SWG0005E	69	24.0 X 12.5 X 23.0
3.7	5	7	SWG0007E	70	24.0 X 12.5 X 23.0
5.5	7.5	9	SWG0009E	72	24.0 X 12.5 X 23.0
7.5	10	12	SWG0012E	75	24.0 X 12.5 X 23.0
11	15	17	SWG0017E	81	24.0 X 12.5 X 23.0
15	20	22	SWG0022E	89	24.0 X 12.5 X 23.0
18.5	25	27	SWG0027E	95	24.0 X 12.5 X 23.0
22	30	35	SWG0035E	95	24.0 X 12.5 X 23.0
30	40	45	SWG0045E	109	24.0 X 12.5 X 23.0
37	50	55	SWG0055E	148	33.9 X 18.3 X 26.0
45	60	65	SWG0065E	163	33.9 X 18.3 X 26.0
55	75	80	SWG0080E	177	33.9 X 18.3 X 26.0
75	100	110	SWG0110E	191	33.9 X 18.3 X 26.0
90	125	130	SWG0130E	345	51.3 X 27.7 X 30.0
110	150	160	SWG0160E	379	51.3 X 27.7 X 30.0
150	200	200	SWG0200E	427	51.3 X 27.7 X 30.0
185	250	250	SWG0250E	744	87.6 X 43.7 X 40.1
220	300	305	SWG0305E	803	87.6 X 43.7 X 40.1
250	350	365	SWG0365E	797	87.6 X 43.7 X 40.1
335	450	415	SWG0415E	830	87.6 X 43.7 X 40.1
375	500	515	SWG0515E	962	87.6 X 43.7 X 40.1
450	600	600	SWG0600E	1,187	87.6 X 43.7 X 40.1
525	700	720	SWG0720E	1,510	84.0 X 52.0 X 45.5
675	900	865	SWG0865E	1,553	84.0 X 52.0 X 45.5
750	1000	1000	SWG1000E	1,536	84.0 X 52.0 X 45.5
935	1250	1200	SWG1200E	2,018	84.0 X 52.0 X 45.5

5. HOW TO INSTALL

Installation Checklist

 WARNING	<p>Prior to installation, please review the safety instructions on page 1 & 2. Failure to practice this can result in body injury!</p>
	<p>Input and output wiring to the filter should be performed by authorized personnel in accordance with NEC and all local electrical codes and regulations.</p>
 WARNING	<p>The filter is designed for use with copper conductors with a minimum temperature rating of 75 degrees C.</p>

SineWave Guardian filters are supplied in the following mechanical configurations:

- Modular: Modular units consist of a reactor and one or more capacitor panel assemblies referred to as cap-panels on drawings and diagrams. Additional wiring between the reactor and capacitor/capacitor panel is required by customer.
- Floor mounted general purpose NEMA 1/2, & NEMA 3R cabinets: Reactor and capacitor/capacitor assemblies are supplied in a cabinet with all items pre-wired together.

Minimum Required Space:

Open panel SineWave Guardian filters are designed for mounting within the customer's enclosure. When determining the internal temperature rise and cooling requirements of the enclosure, include the power dissipation of the filter along with all the other components located in the panel. A general guideline is to allow a side clearance of four (4) inches and a vertical clearance of six (6) inches for proper heat dissipation and access within the enclosure. Clearances may be less if proper ventilation exists. Filter components must operate within temperatures specified in this manual or filter operating life will be compromised. Also, be aware of minimum electrical clearances as defined by the appropriate system safety standard(s). Modular SineWave Guardian filters generate heat and should be positioned away from heat sensitive components. Avoid locations where the filter would be subjected to excessive vibrations. Locate the filter as close to the inverter as possible.

NOTE: Locate the capacitor panel in the lowest temperature regions of the enclosure – generally toward the bottom and away from high temperature components.

General purpose NEMA 1/2 and NEMA 3R enclosed filters are designed for floor mounting in an environment suitable for the enclosure type. Do not install in or near a corrosive environment. Avoid locations where the filter would be subjected to excessive vibrations. Allow a minimum side and back clearance of eight (8) inches and front clearance of thirty-six (36) inches for proper heat dissipation and access.

Grounding

 WARNING	The filter must always be grounded with a grounding conductor connected to ground terminals.
	For modular units, ensure a 2" X 2" area is cleaned of paint and varnish on lower mounting bracket for ground connection.

NOTE: For cable shield grounding follow the drive manufacturer's recommendations.

Grounding and Ground Fault Protection

Due to high leakage currents associated with variable frequency drives, ground fault protective devices do not necessarily operate correctly when placed ahead of a SineWave Guardian filter feeding a drive. When using this type of device, its function should be tested in the actual installation.

Overtemperature Interlock

An overtemperature interlock circuit should be used in conjunction with thermal switch to turn off the drive to prevent filter damage due to abnormal operating conditions. The temperature switch is normally closed and will open when an internal reactor temperature of 180°C is reached. See Table 5-1: Overtemperature Switch, below for contact rating information and the drive user manual for interconnection information.

Table 5-1: Overtemperature Switch

NC Switch opens at 180 Deg. +/- 5 Deg. C		
Current Amps	Voltage	Contact Load
6	120 AC	Resistive Loads
3	120 AC	Inductive Loads
3	240 AC	Resistive Loads
2.5	240 AC	Inductive Loads
8	12 VDC	Resistive Loads
4	24 VDC	Resistive Loads

MTE highly recommends the use of the overtemperature switch to prevent damage to the filter in rare instances of overheating from abnormal operating conditions.

Power Wiring Connection

 WARNING	<p>Input and output power wiring to the filter should be performed by authorized personnel in accordance with the NEC and all local electrical codes and regulations.</p> <p>Cable lugs and mounting hardware are provided by the customer.</p>
	<p>Any extremely low or high resistance readings indicate miswiring and may result in damage to filter components if not corrected.</p>
	<p>On NEMA 3R enclosures, CAB-26AP and larger, no live parts shall be mounted below 8 inches from the bottom of the enclosure.</p>

Verify that the power source to which the filter is to be connected is in agreement with the nameplate data on the filter. A fused disconnect switch or circuit breaker should be installed between the drive and its source of power in accordance with the requirements of the NEC and all local electrical codes and regulations. Refer to the drive user manual for selection of the correct fuse rating and class.

The typical interconnection diagrams that follow are shown for a motor load, but the load can be either a motor or a transformer.

- For modular filter applications, interconnection between the filter, its power source, the cap-panels, and the drive is shown in Figure 5-1: Modular Interconnection (p27).
- For filters supplied in general purpose NEMA 1/2 & NEMA 3R cabinets, interconnection between the filter, its power source, the motor, and the drive is shown in Figure 5-2: Enclosed Interconnection (p28).
- For isolation transformer connections between the power source, the filter, the motor and the drive is shown in Figure 5-4: Isolation Transformer (p30).

NOTE: Standard 600V cable can be used between the SineWave Guardian and the motor, however it is recommended that shielded cable be used if the intention is to mitigate common mode. If shielded cable is used between the filter and motor, it must be grounded accordingly. For optimal common mode mitigation, MTE recommends the [SineWave Nexus](#) motor protection filter.

Refer to the drive manufacturer’s guidelines for:

- Interconnecting the drive and motor and the correct start-up procedures for the drive.
- Cable type used between the drive and SineWave Guardian.

The filter is designed for use with copper conductors with a minimum temperature rating of 75 degrees C.

Wiring Checks

Using Figure 5-3: Basic Schematic Diagram (p29), visually check the wired components to confirm, verify, and correct wiring. Then, with a multimeter check phase to phase isolation using the 100 K ohm range. The multi meter will read the parallel equivalent of the bleeder resistors after the capacitors initially charge. All phase to phase resistance values should be the same.

Check for the Following Faults:

- Capacitor shorted
- Capacitor bus not connected
- Capacitor bus to chassis short
- Parallel wiring errors

Torque Ratings Tables

Please see Table 5-2: Torque Ratings 208V-240V (p31), Table 5-3: Torque Ratings 380V-480V (p32), and Table 5-4: Torque Ratings 600V (p34) for torque ratings.

NOTE: Cap-panel interconnect wiring specification according to UL508 75° C Table.

NOTE: All capacitor and cappanel part numbers will be CAP-xxxTP, CAP-xxxSW, CAPPANEL-xxx or CAPPANEL-xxxC.

NOTE: To prevent flexing or bending of the coil windings attached to SWG reactor use appropriate strain relief to prevent stress on terminals. For flat copper terminal tabs, use two wrenches to tighten customer provided cable mounting hardware.

NOTE: Refer to reference drawings for termination wire ranges.

Modular Unit Interconnection Diagram

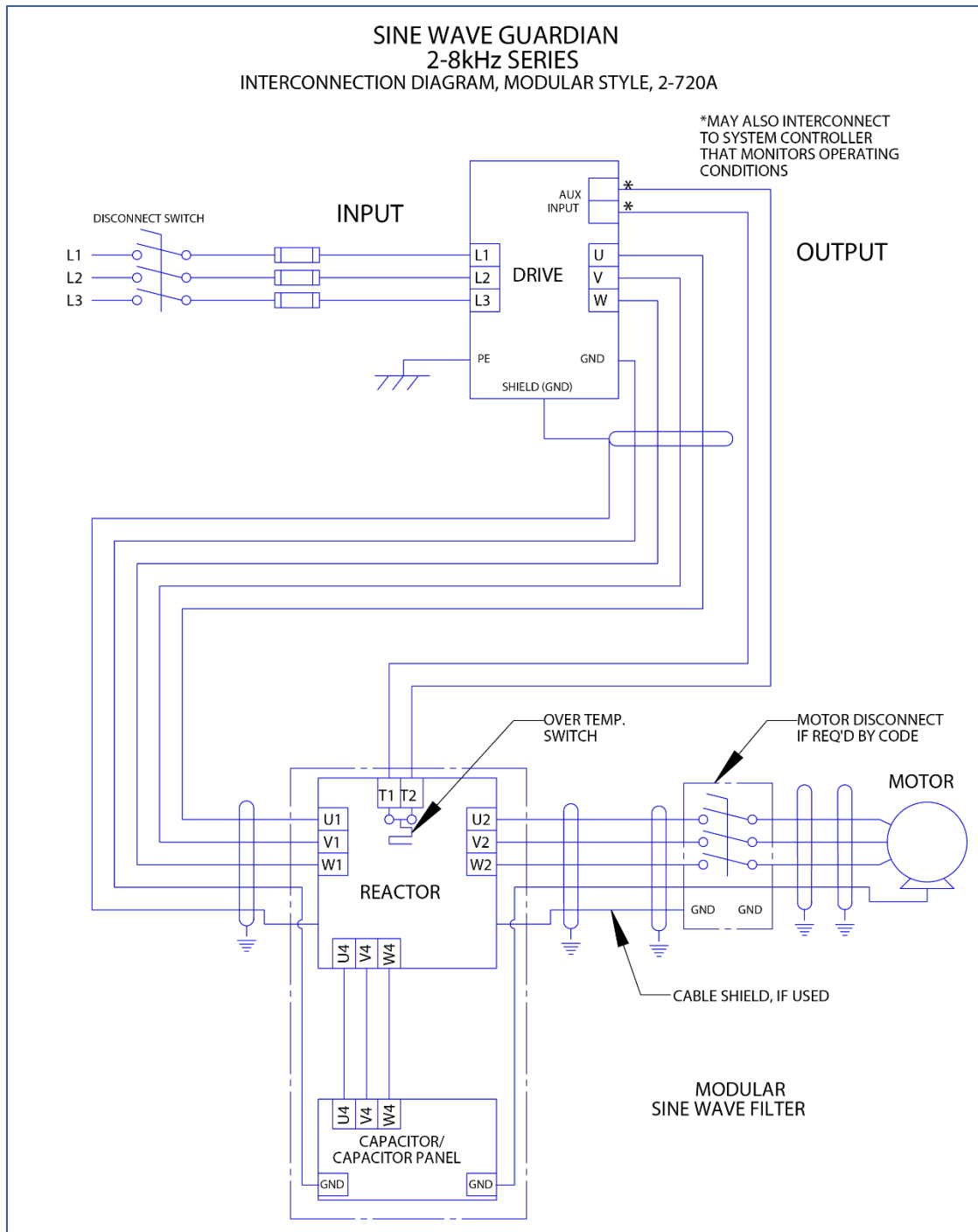

Enclosed Unit Interconnection Diagram

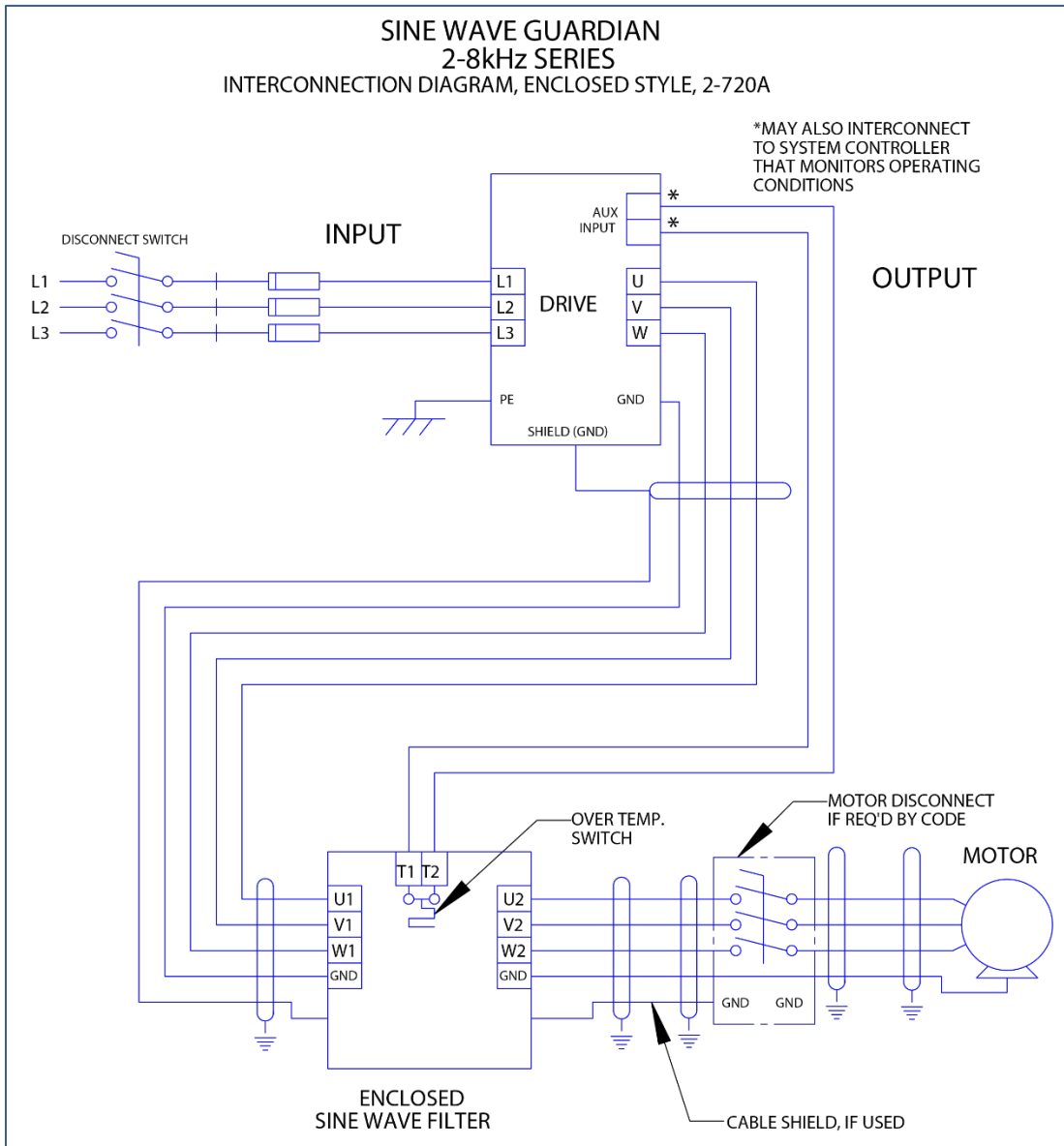

Basic Schematic Diagram

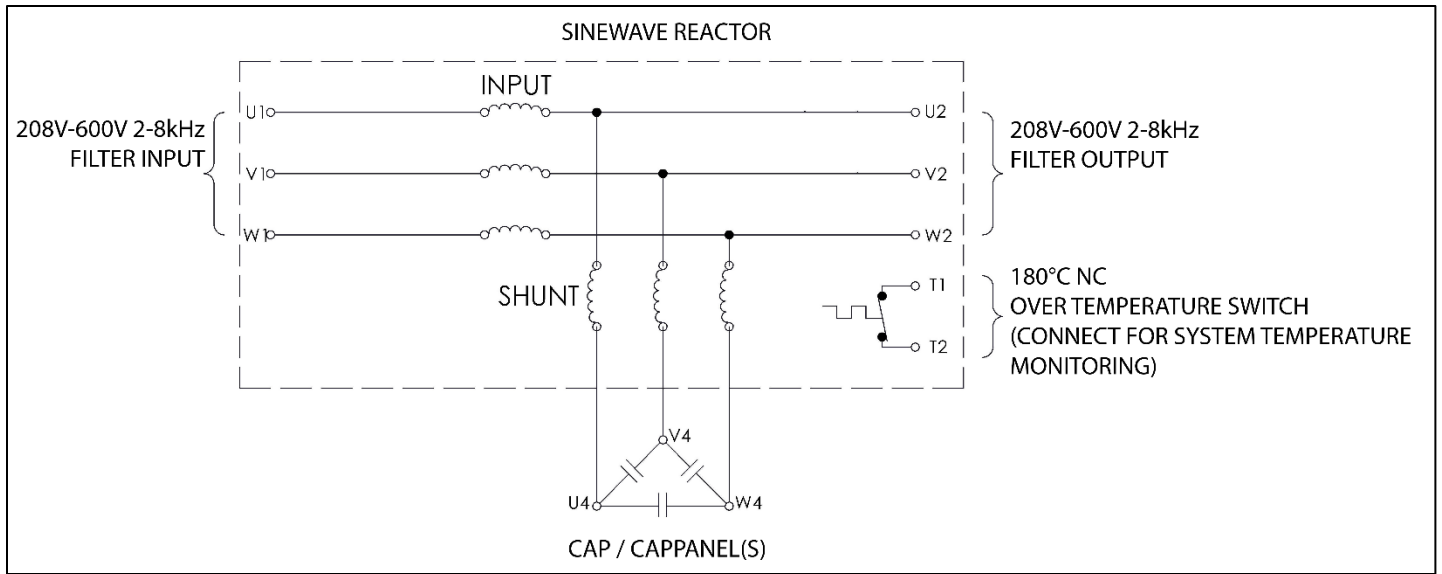
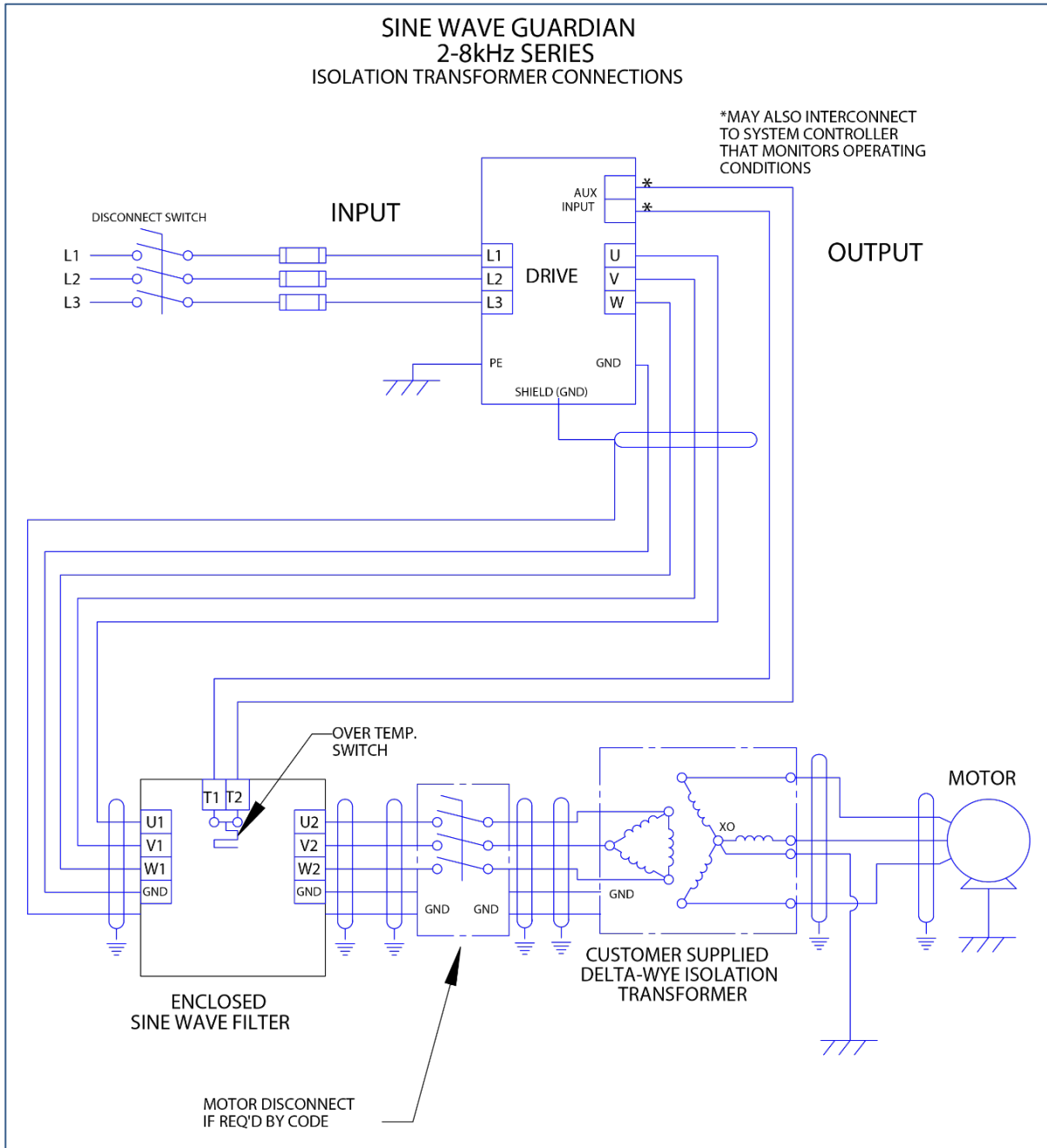

Figure 5-3: Basic Schematic Diagram

Isolation Transformer Diagram



Torque Ratings 208V-240V

Table 5-2: Torque Ratings 208V-240V

Filter Rating (Amps)	SWG Terminals			Cap-panel Terminals U4-V4-W4		
	Input /Output Power U1-V1-W1 / U2-V2-W2		U4-V4-W4 interconnect Cap-panel	Capacitor/ Cap-panel Part Number	Minimum Interconnect Wire Gauge (AWG)	Terminal Torque (in-lbs.)
	Recommended Minimum Wire Size (AWG)	Terminal Torque (in-lbs.)	Terminal Torque (in-lbs.)			
9	14	16	16	CAP-507SW	14	23
12	14	16	16	CAP-508SW	14	23
17	12	16	16	CAP-510SW	14	23
22	10	16	16	CAP-528SW	14	23
30	8	16	16	CAP-513SW	14	23
45	8	16	16	CAP-531SW	14	23
55	6	N/A	16	CAP-515SW	14	23
70	6	N/A	16	CAP-537SW	14	23
85	4	N/A	16	CAP-538SW	12	23
110	2	N/A	N/A	CAP-539SW	10	23
135	1	N/A	N/A	CAP-537SW	10	23
160	4 (2x) or 2/0	N/A	N/A	CAP-541SW	8	23
200	3 (2x) or 1/0	N/A	N/A	CAP-542SW	8	23
250	1 (2x) or 250K CMIL	N/A	N/A	CAP-538SW	8	23
			N/A	CAP-541SW	8	23
320	2/0 (2x)	N/A	N/A	CAPPANEL-185	4	60

Torque Ratings 380V-480V

Table 5-3: Torque Ratings 380V-480V

Filter Rating (Amps)	SWG Terminals			Cap-panel Terminals U4-V4-W4		
	Input /Output Power U1-V1-W1 / U2-V2-W2		U4-V4-W4 interconnect Cap-panel	Capacitor/ Cap-panel Part Number	Minimum Interconnect Wire Gauge (AWG)	Terminal Torque (in-lbs.)
	Recommended Minimum Wire Size (AWG)	Terminal Torque (in-lbs.)	Terminal Torque (in-lbs.)			
2	14	16	16	CAP-501SW	14	23
3	14	16	16	CAP-502SW	14	23
5	14	16	16	CAP-503SW	14	23
7	14	16	16	CAP-504SW	14	23
9	14	16	16	CAP-505SW	14	23
12	14	16	16	CAP-506SW	14	23
17	12	16	16	CAP-507SW	14	23
22	10	16	16	CAP-508SW	14	23
27	10	N/A	16	CAP-509SW	14	23
35	8	N/A	16	CAP-510SW	14	23
45	8	16	16	CAP-511SW	14	23
55	6	N/A	16	CAP-512SW	14	23
65	6	N/A	16	CAP-513SW	14	23
80	4	N/A	N/A	CAP-514SW	12	23
110	2	N/A	N/A	CAP-515SW	10	23
130	1	N/A	N/A	CAP-516SW	10	23
160	4 (2x) or 2/0	N/A	N/A	CAPPANEL-604(C)	8	60
200	3 (2x) or 1/0	N/A	N/A	CAPPANEL-605(C)	8	60
250	1 (2x) or 250K CMIL	N/A	N/A	CAPPANEL-606(C)	6	60
305	2/0 (2x)	N/A	N/A	CAPPANEL-623(C)	4	60
365	3/0 (2x)	N/A	N/A	CAPPANEL-608(C)	4	60
415	4/0 (2x)	N/A	N/A	CAPPANEL-609(C)	3	60
515	300 MCM (2)	N/A	N/A	CAPPANEL-610(C)	2	60
600	400K CMIL (2x)	N/A	N/A	CAPPANEL-611(C)	1/0	60
720	500K CMIL (2x)	N/A	N/A	CAPPANEL-608(C)	4	60
			N/A	CAPPANEL-611(C)	1/0	60



Filter Rating (Amps)	SWG Terminals			Cap-panel Terminals U4-V4-W4		
	Input /Output Power U1-V1-W1 / U2-V2-W2		U4-V4-W4 interconnect Cap-panel	Capacitor/ Cap-panel Part Number	Minimum Interconnect Wire Gauge (AWG)	Terminal Torque (in-lbs.)
	Recommended Minimum Wire Size (AWG)	Terminal Torque (in-lbs.)	Terminal Torque (in-lbs.)			
850	500K CMIL (3x)	N/A	N/A	CAPPANEL-572(C)	2	60
			N/A	CAPPANEL-619(C)	1	
1,000	600K CMIL (3x)	N/A	N/A	CAPPANEL-623(C)	1/0	60
			N/A	CAPPANEL-624(C)	1	
1,200	800K CMIL (3x)	N/A	N/A	CAPPANEL-611(C)	1	60
1,500	1000K CMIL	N/A	N/A	CAPPANEL-577(C)	1/0	60

Torque Ratings 600V

Table 5-4: Torque Ratings 600V

Filter Rating (Amps)	SWG Terminals			Cap-panel Terminals U4-V4-W4		
	Input /Output Power U1-V1-W1 / U2-V2-W2		U4-V4-W4 interconnect Cap-panel	Capacitor/ Cap-panel Part Number	Minimum Interconnect Wire Gauge (AWG)	Terminal Torque (in-lbs.)
	Recommended Minimum Wire Size (AWG)	Terminal Torque (in-lbs.)	Terminal Torque (in-lbs.)			
2	14	16	16	CAP-534SW	14	23
3	14	16	16	CAP-535SW	14	23
5	14	16	16	CAP-518SW	14	23
7	14	16	16	CAP-520SW	14	23
9	14	16	16	CAP-519SW	14	23
12	14	16	16	CAP-522SW	14	23
17	12	16	16	CAP-523SW	14	23
22	10	16	16	CAP-524SW	14	23
27	10	16	16	CAP-525SW	14	23
35	8	16	16	CAP-526SW	14	23
45	8	16	16	CAP-527SW	14	23
55	6	16	16	CAP-528SW	14	23
65	6	16	16	CAP-529SW	14	23
80	4	16	16	CAP-530SW	12	23
110	2	16	16	CAP-531SW	10	23
130	1	N/A	N/A	CAP-532SW	8	23
160	4 (2x) or 2/0	N/A	N/A	CAP-533SW	8	23
200	3 (2x) or 1/0	N/A	N/A	CAPPANEL-157	4	60
250	1 (2x) or 250K CMIL	N/A	N/A	CAPPANEL-161	4	60
305	2/0 (2x)	N/A	N/A	CAPPANEL-161	4	60
			N/A	CAPPANEL-162	14	23
365	3/0 (2x)	N/A	N/A	CAPPANEL-161	4	60
			N/A	CAPPANEL-163	10	23
415	4/0 (2x)	N/A	N/A	CAPPANEL-161	4	60
			N/A	CAPPANEL-163	10	23
515	300 MCM (2x)	N/A	N/A	CAPPANEL-157	4	60
			N/A	CAPPANEL-161	4	
600	400K CMIL (2x)	N/A	N/A	CAPPANEL-161	4	60
			N/A	CAPPANEL-164	12	23
720	500K CMIL (2x)	N/A	N/A	CAPPANEL-161	4	60
			N/A	CAPPANEL-157	4	60
			N/A	CAP-525SW	14	23





SineWave Guardian® Technical Reference Manual 208V - 600V

Filter Rating (Amps)	SWG Terminals			Cap-panel Terminals U4-V4-W4		
	Input /Output Power U1-V1-W1 / U2-V2-W2		U4-V4-W4 interconnect Cap-panel	Capacitor/ Cap-panel Part Number	Minimum Interconnect Wire Gauge (AWG)	Terminal Torque (in-lbs.)
	Recommended Minimum Wire Size (AWG)	Terminal Torque (in-lbs.)	Terminal Torque (in-lbs.)			
865	500K CMIL (3x)	N/A	N/A	CAPPANEL-161	4	60
			N/A	CAPPANEL-157	4	
1,000	600K CMIL (3x)	N/A	N/A	CAPPANEL-161	4	60
			N/A	CAPPANEL-157	4	
1,200	800K CMIL (3x)	N/A	N/A	CAPPANEL-161	4	60
			N/A	CAP-533SW	8	23
1,500	1000K CMIL	N/A	N/A	CAPPANEL-161	4	60
			N/A	CAP-532SW	8	23

6. START-UP

Startup Checklist



Before start-up, observe the following warnings and instructions:

 WARNING	<p>Internal components of the filter are at line potential when the filter is connected to the drive. This voltage is extremely dangerous and may cause death or severe injury if you come in contact with it.</p>
	<p>Remove all power to the SineWave filter in compliance to standardized 26 CFR 1920.147 lockout/tagout policies. After disconnecting the utility power, allow at least 5 minutes to elapse and verify that the capacitors have discharged to a safe level before contacting internal components. Connect a DC voltmeter across the capacitor terminals and ensure that the voltage is at a safe level.</p>
	<p>Use extreme caution to avoid contact with line voltage when checking for power. INJURY OR DEATH MAY RESULT IF SAFETY PRECAUTIONS ARE NOT OBSERVED.</p>
 Caution	<p>Prior to start-up; confirm the drive operation mode is properly set. Please consult drive manual/manufacturer to configure proper parameters. Failure to do so may result in failure of drive or filter components.</p>
	<p>Damage to the filter may occur if the output frequency is not set between 2 kHz and 8 kHz. Optimum output frequency is 2kHz to 3kHz.</p>
	<p>MTE recommends 10 seconds as an initial starting point for motor ramp time and that customers examine the actual inrush and ratings of their drive system. Inrush current seen at the drive from the filter that can easily be overcome by changing the motor ramp time.</p>

Sequence of Operation

1. Read and follow safety precautions.
2. After installation, ensure that:
 - a. All filter ground terminals are connected to ground.
 - b. Power wiring to the utility, drive, filter and motor is in accordance with the power wiring connection diagrams shown in installation instructions section.
3. Check that moisture has not condensed on the filter components. If moisture is present, do not proceed with startup until the moisture has been removed.
4. Disconnect filter output terminals from the motor.
5. Set the drive switching frequency between 2 kHz and 8 kHz. Refer to the drive user manual.
6. Connect filter temperature safety overload switch into the control circuit so that the drive will shut down in an overload situation.
7. Confirm that drive voltage is present at the input terminals (U1, V1, W1) of the filter.
8. Confirm that motor voltage is present at the output terminals (U2, V2, W2) of the filter.
9. Connect the filter output to the motor.
10. Refer to the drive user manual for the drive startup procedure. Observe all safety instructions in the drive user manual.
11. Contact factory if the drive requires filter inductors and capacitor values for SineWave set-up.

7. TROUBLESHOOTING

 WARNING	<p>When properly installed, this equipment has been designed to provide maximum safety for operating personnel. However, hazardous voltages and elevated temperatures exist within the confines of the enclosure. Servicing should therefore be performed by qualified personnel only and in accordance with OSHA Regulations.</p>
	<p>High voltage is used in the operation of this filter. Use Extreme caution to avoid contact with high voltage when operating, installing or repairing this filter. INJURY OR DEATH MAY RESULT IF SAFETY PRECAUTIONS ARE NOT OBSERVED.</p>
 Caution	<p>After removing power, allow at least five minutes to elapse and verify that the capacitors have discharged to a safe level before contacting internal components. Connect a DC voltmeter across the capacitor terminals or terminals U1, V1 or V1, W1 and ensure that the voltage is at a safe level.</p>

To aid in troubleshooting, a basic schematic diagram, two interconnection diagrams, and a troubleshooting guide that lists potential problems and solutions are included:

Figure 5-1: Modular Interconnection (p27)

Figure 5-2: Enclosed Interconnection (p28)

Figure 5-3: Basic Schematic Diagram (p29)

Table 7-1: Troubleshooting Guide (p40)

SineWave Guardian Motor Protection Filter Field Checks

1. Disconnect all power and remove input power wiring from U1, V1, W1 terminals.
2. Remove VFD drive power connections from filter terminals U2, V2, W2 and any contactor or temperature switch wiring. (For filters using control transformers: remove power fuses on top of transformer.)
3. Visually inspect filter terminals and wiring lugs for signs of heat and corrosion. **Contact factory if any wires appear to be missing or cut!**
4. Inspect the U4, V4, W4 capacitor interconnect terminals and wiring.
5. Visually inspect all capacitors for signs of case deformation, bowing of the top, leaking oil or terminal damage. Note the CAP- # and date code of any damaged capacitors.
6. Using a multi meter set to read 100K ohms check:
 - a. Phase to phase U1-V1-W1-U1 (mechanically activate contactor if present) after reactor and caps charge reading should be about 40K (total equivalent bleeder resistance value) and should be the same for each phase. Open circuit or very low readings indicate a problem.
 - b. Phase to chassis U1- case, V1-case, W1- case; low readings indicate a ground fault problem.
7. Ensure the “disconnect” is safe, then wire the utility power to U1, V1, W1.
8. Apply power and verify that proper output voltage is present on U2, V2, and W2.
9. Using a clamp on amp meter read the filter input current:
 - a. Readings will be 0.5 of the capacitor current listed in Table 3-2: Filter Efficiency + Watt Loss SineWave Guardian 208V-240V, 60Hz (p6), Table 3-3: Filter Efficiency + Watt Loss SineWave Guardian 380V-480V, 60Hz (p7), Table 3-4: Filter Efficiency + Watt Loss SineWave Guardian 600v, 60Hz (p8) for the listed filter current in the user manual (mechanically activate the contactor if the filter is equipped with one). Readings should be the same (+/- 5%) for all phase currents; **contact the factory if currents are out of tolerance!**
 - b. Open contactor readings will show zero current for all phases.
10. Disconnect filter power and wire the VFD to U2, V2, and W2 as well as any control wiring to the filter contactor or temperature switch. Replace any control transformer fuses. Follow the drive power start-up guidelines in the drive manufacturer’s user manual.

Table 7-1: Troubleshooting Guide

PROBLEM:	Drive Overcurrent Fault
Possible cause:	Motor ramp-up time too short.
Solution:	MTE suggests a ramp time of >5-10 seconds. Consult drive manufacturers manual to configure proper parameters.
Possible cause:	Failed or incorrect wiring
Solution:	Verify all field and product wiring is correct.
Possible cause:	Parameter compatibility.
Solution:	Consult drive manufacturer's manual for operating drive with a motor protection filter.
Possible cause:	Filter, Drive, Motor current ratings incompatible.
Solution:	Verify the filter and motor are properly sized for the application.
Possible cause:	Drive operation mode is not properly set.
Solution:	Consult drive manufacturers manual to configure proper parameters.
Possible cause:	Motor winding fault.
Solution:	Verify motor windings and hi-pot is necessary.
Possible cause:	Cable failure.
Solution:	Verify cable continuity and insulation.
PROBLEM:	Excessive Filter Noise
Possible cause:	Mismatched motor rating.
Solution:	Verify the filter is properly sized for the application.
Possible cause:	Capacitors disconnected or improperly wired.
Solution:	Verify the proper connection of the capacitors.
Possible cause:	Carrier frequency less than 2 kHz.
Solution:	Verify the carrier frequency is at least 2 kHz.
PROBLEM:	Temperature Switch Open
Possible cause:	Mismatched motor rating.
Solution:	Verify the filter is properly sized for the application.
Possible cause:	Capacitors disconnected or improperly wired.
Solution:	Verify the proper connection of the capacitors.
Possible cause:	Carrier frequency less than 2 kHz.
Solution:	Verify the carrier frequency is at least 2 kHz.
Possible cause:	Excessive ambient temperature.
Solution:	Ensure filter is operating within specified ambient temperature below 60° C.
PROBLEM:	Motor will not turn.
Possible cause:	No power.
Solution:	Check fuses or breakers for proper input power.
Possible cause:	Motor incorrectly wired.
Solution:	Check for wiring faults.
Possible cause:	Locked rotor motor load.
Solution:	Check motor load.
Possible cause:	Drive fault.
Solution:	Consult drive manufacturers manual.
Possible cause:	Capacitors disconnected or improperly wired.
Solution:	Verify the proper connection of the capacitors.
Possible cause:	Overloaded motor.
Solution:	Verify the motor is properly sized for the application.