



POWER QUALITY. SOLVED.

A STEEL PARTNERS COMPANY

RL Line/Load Reactors

208V – 690V

TECHNICAL REFERENCE MANUAL

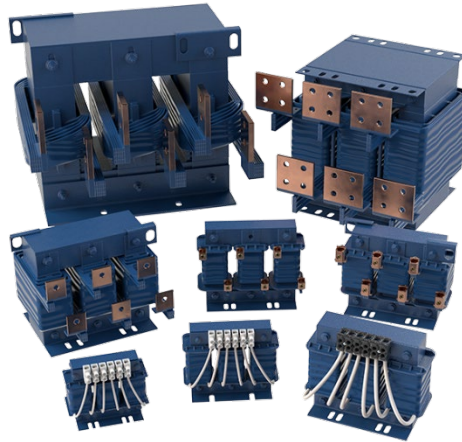

WARNING

High Voltage! Only a qualified electrician can carry out the electrical installation of this filter.

Quick Reference

①	Performance Data	Pages 5 - 7
②	Selection Guide	Pages 8 - 35
③	Installation Guide	Pages 36 - 42
④	Start-up/Troubleshooting	Pages 43 - 45

This page intentionally left blank

TABLE OF CONTENTS

RL LINE/LOAD REACTORS	III
1. SAFETY	1
WARNINGS AND CAUTIONS	1
GENERAL SAFETY INSTRUCTIONS	2
2. GENERAL INFORMATION	3
RECEIPT & REPAIR STATEMENT	3
ENCLOSURES	4
AGENCY APPROVALS	4
WARRANTY	4
3. RL LINE/LOAD REACTORS PERFORMANCE DATA	5
PERFORMANCE SPECIFICATIONS	5
AUDIBLE NOISE.....	6
SERVICE FACTOR	6
PWM / IGBT PROTECTION	6
HARMONIC ATTENUATION.....	6
ALTITUDE DERATING	7
TEMPERATURE DERATING	7
4. HOW TO SELECT	8
SELECTION GUIDE	8
UNDERSTANDING THE RL LINE/LOAD REACTOR PART NUMBER:	9
RL LINE/LOAD REACTOR OPTIONS:	10
<i>Lug Option Details:</i>	10
RL LINE/LOAD REACTORS 120V – 600V SINGLE PHASE	11
<i>Part Number Selection Tables</i>	11
RL LINE/LOAD REACTORS 208 VOLTS, 60HZ.....	12
<i>Part Number Selection Tables</i>	12
RL LINE/LOAD REACTORS 208 VOLTS, 60HZ.....	13
<i>Part Number Selection Tables</i>	13
RL LINE/LOAD REACTORS 240 VOLTS, 60HZ.....	14
<i>Part Number Selection Tables</i>	14
RL LINE/LOAD REACTORS 240 VOLTS, 60HZ.....	15
<i>Part Number Selection Tables</i>	15
RL LINE/LOAD REACTORS 400 VOLTS, 50HZ.....	16
<i>Part Number Selection Tables</i>	16
RL LINE/LOAD REACTORS 400 VOLTS, 50HZ.....	17
<i>Part Number Selection Tables</i>	17
RL LINE/LOAD REACTORS 480 VOLTS, 60HZ.....	18
<i>Part Number Selection Tables</i>	18
RL LINE/LOAD REACTORS 480 VOLTS, 60HZ.....	19
<i>Part Number Selection Tables</i>	19
RL LINE/LOAD REACTORS 600 VOLTS, 60HZ.....	20
<i>Part Number Selection Tables</i>	20
RL LINE/LOAD REACTORS 600 VOLTS, 60HZ.....	21
<i>Part Number Selection Tables</i>	21
RL LINE/LOAD REACTORS 690 VOLTS, 50HZ.....	22
<i>Part Number Selection Tables</i>	22
RL LINE/LOAD REACTORS 690 VOLTS, 50HZ.....	23
<i>Part Number Selection Tables</i>	23
RL LINE/LOAD REACTORS	24

<i>Open Dimension Reference</i>	24
RL LINE/LOAD REACTORS	25
<i>Technical and Mechanical Specifications</i>	25
RL LINE/LOAD REACTORS	26
<i>Technical and Mechanical Specifications</i>	26
RL LINE/LOAD REACTORS	27
<i>Technical and Mechanical Specifications</i>	27
RL LINE/LOAD REACTORS	28
<i>Technical and Mechanical Specifications</i>	28
RL LINE/LOAD REACTORS	29
<i>Technical and Mechanical Specifications</i>	29
RL LINE/LOAD REACTORS	30
<i>Technical and Mechanical Specifications</i>	30
RL LINE/LOAD REACTORS	31
<i>Technical and Mechanical Specifications</i>	31
RL LINE/LOAD REACTORS	32
<i>Technical and Mechanical Specifications</i>	32
RL LINE/LOAD REACTORS	33
<i>Technical and Mechanical Specifications</i>	33
RL LINE/LOAD REACTORS	34
<i>Technical and Mechanical Specifications</i>	34
RL LINE/LOAD REACTORS	35
<i>Technical and Mechanical Specifications</i>	35
5. HOW TO INSTALL	36
INSTALLATION CHECKLIST	36
GROUNDING	37
POWER WIRING CONNECTION	38
TYPICAL CONNECTION DIAGRAMS	39
TORQUE RATINGS.....	40
TORQUE RATINGS.....	41
TORQUE RATINGS.....	42
6. START-UP	43
SAFETY PRECAUTIONS	43
7. TROUBLESHOOTING	44

List of Figures

Figure 3-1: Altitude Derating Curve.....	7
Figure 3-2: Temperature Derating.....	7
Figure 5-1: Line Reactor.....	39
Figure 5-2: Load Reactor.....	39
Figure 5-3: Multiple Line Reactors.....	39
Figure 5-4: Single Phase Line Reactors.....	39



List of Tables

Table 3-1: Performance Specifications.....	5
Table 4-1: RL Reactors 120V – 600V – Single Phase.....	11
Table 4-2: RL Reactors 208V – 3-Phase.....	12
Table 4-3: RL Reactors 208V – 3-Phase.....	13
Table 4-4: RL Reactors 240V – 3-Phase.....	14
Table 4-5: RL Reactors 240V – 3-Phase.....	15
Table 4-6: RL Reactors 400V – 3-Phase.....	16
Table 4-7: RL Reactors 400V – 3-Phase.....	17
Table 4-8: RL Reactors 480V – 3-Phase.....	18
Table 4-9: RL Reactors 480V – 3-Phase.....	19
Table 4-10: RL Reactors 600V – 3-Phase.....	20
Table 4-11: RL Reactors 600V – 3-Phase.....	21
Table 4-12: RL Reactors 690V – 3-Phase.....	22
Table 4-13: RL Reactors 690V – 3-Phase.....	23
Table 4-14: RL Reactors Open Panel Technical Specifications.....	25
Table 4-15: RL Reactors NEMA 1/2 Technical Specifications.....	30
Table 4-16: RL Reactors NEMA 3R Technical Specifications.....	33
Table 5-1: RL Reactors Torque Ratings.....	40
Table 7-1: Troubleshooting Guide.....	45



1. SAFETY

Warnings and Cautions

The following symbols are used in this manual:

 WARNING	High Voltage Warning: warns of situations that dangerously high voltage is involved. Failure to use proper precautions may lead to serious injury or death.
 WARNING	General Warning: warns of situations that can result in serious injury or death if proper precautions are not used.
 Caution	General Caution: identifies situations that could lead to malfunction or possible equipment damage.

General Safety Instructions

 WARNING	<p>High Voltage! Only a qualified electrician can carry out the electrical installation of this filter.</p>
	<p>High voltage is used in the operation of line/load reactors. Use extreme caution to avoid contact with high voltage when operating, installing or repairing line/load reactors. Injury or death may result if safety precautions are not observed.</p>
	<p>Line/load reactors are used in conjunction with inverters, or other electrical equipment that may feedback lethal voltages. Follow the safety instructions in the equipment used with the reactor in addition to the safety instructions in this manual.</p>
 WARNING	<p>The opening of the branch circuit protective device may be an indication that a fault current has been interrupted. To reduce the risk of fire or electrical shock, line/load reactors should be examined and replaced if damaged.</p>
	<p>An upstream disconnect/protection device must be used as required by the National Electrical Code (NEC) or governing authority.</p>
	<p>Even if the upstream disconnect/protection device is open, the drive downstream of the line/load reactor may feedback high voltage to the reactor. The drive safety instructions must be followed. Injury or death may result if safety precautions are not observed.</p>
	<p>Line/load reactors must be grounded with a grounding conductor connected to all grounding terminals. Open panel reactors must have a 2"x2" area cleaned of paint and varnish on the lower mounting bracket.</p>
	<p>Only spare parts obtained from MTE Corporation or an authorized MTE distributor can be used.</p>
 Caution	<p>Loose or improperly secured connections may damage or degrade reactor performance. Visually inspect and secure all electrical connections before power is applied to the filter.</p>
	<p>The user of this reactor must assure that the input voltage and frequency is correct for the reactor rating and that the voltage applied falls within the rated operating tolerance envelop specified for the reactor. For severe power line applications where the power feed is likely to experience surges and transients that exceed the input voltage rating, it is recommended that a TVSS (Transient Voltage Surge Suppression) or SPD (Surge Protection Device) be deployed ahead of the reactor to reduce the possibility of exceeding the reactor's rated voltage. Consult with TVSS or SPD manufacturer to determine the correct protection requirements for your power line conditions.</p>

2. GENERAL INFORMATION

The purpose of this manual is to properly specify, size, and install the RL Series Line/Load Reactors.

For most current information, please refer to website
<https://www.mtecorp.com/products/reactors/rl-reactors/>

Receipt & Repair Statement

Upon Receipt of this Filter:

RL Line/Load Reactors have been subjected to demanding factory tests before shipment. Carefully inspect the shipping container for damage that may have occurred in transit. Then unpack the reactor and carefully inspect for any signs of damage. Save the shipping container for future transport of the reactor.

In the event of damage, please contact and file a claim with the freight carrier involved immediately.

If the equipment is not going to be put into service upon receipt, cover and store the reactor in a clean, dry location. After storage, ensure that the equipment is dry and that no condensation or dirt has accumulated on the reactor before applying power.

Repair/Exchange Procedure

MTE Corporation requires a Return Material Authorization Number and form before we can accept any reactors that qualify for return or repair. If problems or questions arise during installation, setup, or operation of the reactor, please contact MTE for assistance at:

Toll Free: 1-800-455-4MTE (1-800-455-4683)

International Tel: (+1)262-253-8200

Fax: (+1)262-253-8222

Enclosures

MTE enclosures are designed to provide a degree of protection for electrical components and prevent incidental personnel contact with the enclosed equipment. Depending on the enclosure selected, these enclosures meet the requirements of NEMA 1/2 or 3R.

An approximate cross reference guide between NEMA, UL, CSA and IEC enclosure follows.

Type 1 NEMA / IEC IP20 Enclosure:

Are designed for indoor use and will provide protection against contact with the enclosed equipment.

Type 2 NEMA / IEC IP20 Enclosure:

Are designed for indoor use and will provide protection against contact with the enclosed equipment and provide a degree of protection against limited amounts of falling water and dirt.

Type 3R NEMA / IEC IP23 Enclosure:

Are designed for outdoor use primarily to provide protection against contact with the enclosed equipment and provide a degree of protection against falling rain sleet and external ice formation.

Agency Approvals

UL-508,	File E180243 Component Listed (1 amp – 2400 amps)
UL-508,	File E180243 UL Listed NEMA 1 units (1 amp – 2400 amps)
CSA C22.2,	File LR29753-13 CSA Certified (1 amp – 2400 amps)
Class N, 200° C,	File E66214, Type 200-18, UL Recognized Insulation System
CE Marked	

Warranty

Five (5) years from the date of shipment. See <https://www.mtecorp.com/industry-leading-warranty/> for details.

3. RL LINE/LOAD REACTORS PERFORMANCE DATA

Performance Specifications

Table 3-1: Performance Specifications

Impedance Levels	1.5%, 2%, 3%, 4%, 5% available
Continuous Service Factor*	Reactors rated 1 to 750 Amps – 150% of rating Reactors rated above 750 Amps – 125% rating
Overload Rating	200% of fundamental for 30 minutes 300% of fundamental for 1 minute
Input Voltage(s)	120V – 600V 1 phase 208V – 690V 3 phase
Current Range	1A – 1,500A
Maximum System Voltage	600 Volts (units with terminal blocks) 690 Volts (units with box lugs or tab terminals)
Maximum Switching Frequency	20 kHz
Ambient Temperature (Operating)	-40 to +50 degrees C Open Panel Reactor -40 to +40 degrees C Enclosed Reactor -40 to +90 degrees C Storage
Insulation System	Class N (200° C)
Altitude without derating	3,300 feet above sea level
Fundamental Frequency	50/60 Hz
Inductance Curve	100% at 100% current 100% at 150% current 50% at 350% current (minimum)
Inductance Tolerance	+/- 10%

Notes:

****Select reactor based on fundamental current rating.***

The Short Circuit Current Rating (SCCR) is not required under Exception No.1 of UL508A SB4.2.1 effective 4/25/06.

Audible Noise

RL Line/Load Reactors offer low noise operation. Core and coil construction, flux density control, harmonic compensation as well as our epoxy impregnation process assure minimal audible noise radiation. Although our reactors are typically “quiet”, waveforms vary by drive type and application and therefore reactor audible noise may vary by application. Noise levels may be affected by type of motor and motor conductor as well as motor conductor length.

Typical audible noise levels for units selected from our catalog by HP rating are:

- 2 thru 12 amps 55 dBA
- 18 thru 100 amps 65 dBA
- 130 thru 400 amps 70 dBA
- 500 thru 1200 amps 75 dBA

Service Factor

RL Line/Load Reactors are compensated for the additional currents and high frequencies caused by the presence of harmonics. The reactor fundamental current rating indicates the typical full load motor current and is also the basis of impedance rating. Standard reactors rated 1 amps thru 750 amps offer a full 1.5 service factor rating which allows them to carry overload current up to 150% of their fundamental rating when applied as an input line reactor. Since the nameplate ratings of motor drives (ASD) varies widely by manufacturer, this helps to assure that the reactor maximum current rating is compatible with the nameplate current rating on the ASD. The service factor rating compensates for ASD manufacturer variances in motor drive current ratings and for harmonic currents. Nominal inductance is assured all the way up to the service factor current rating.

PWM / IGBT Protection

RL Line/Load Reactors are protected against the high peak voltage and fast rise time voltage pulses associated with PWM waveforms. The dielectric strength is 4000 volts rms and RL reactors meet the ratings of an inverter duty motor (NEMA MG-1, part 31). For convenience, they can be located either at the motor or at the drive.

Harmonic Attenuation

Our unique harmonic compensation assures maximum circuit inductance in the presence of complex waveforms and can be relied upon to minimize input total harmonic current distortion (THID). Additionally, it offers superior absorption of transient voltage spikes. Our standard reactors will typically reduce 6-pulse rectifier input current harmonics to the following levels at full load operating conditions:

- | | |
|------------------------------------|------------------|
| • 3% reactor alone | 45% or less THID |
| • 5% reactor alone | 35% or less THID |
| • 3% AC reactor + 3% DC link choke | 33% or less THID |
| • 5% AC reactor + 3% DC link choke | 28% or less THID |

(DC link choke inductance is equivalent ac impedance).

Altitude Derating

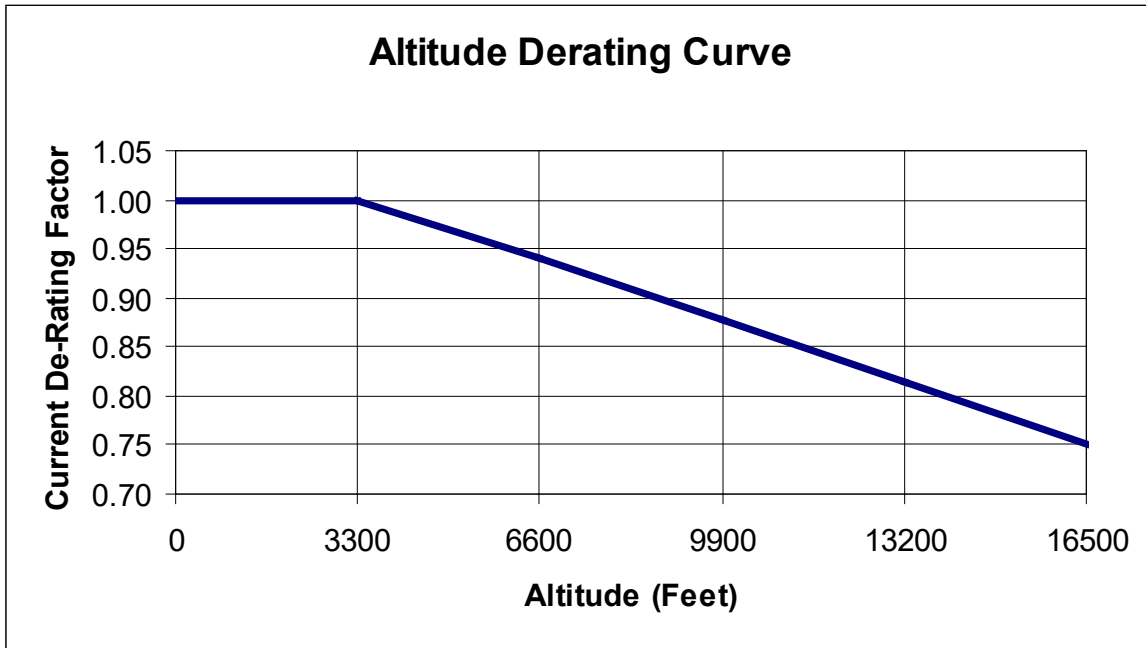

Figure 3-1: Altitude Derating Curve

Temperature Derating

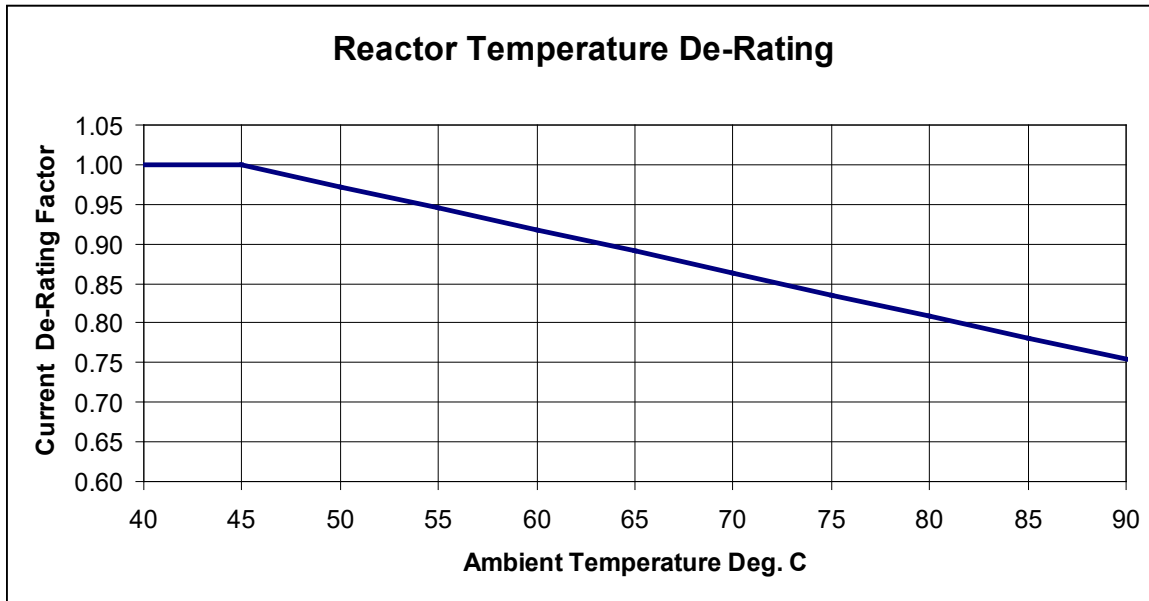

Figure 3-2: Temperature Derating

4. HOW TO SELECT Selection Guide

MTE RL Line/Load Reactors are optimized to support global IEC and NEC Drive /motor applications. RL's are RMS current rated impedance devices. Selection is based on the choice of inductance correlated to the application motor full load amps, voltage and frequency and the number of phases. Use the product selection brochure based on input voltage and NEC FLA motor selection table for common voltages. For critical impedance selection based on specific HP or load currents, consult MTE applications engineering.

Choose the impedance level:

- 3% Reactors rated at 3% are typically sufficient to absorb line spikes and motor current surges, and help prevent nuisance tripping to the drive and circuit breakers in most applications. 3% is typically specified by most drive manufacturers.
- 5% Reactors rated at 5% are best for reducing harmonic current and frequencies. Use them when you must reduce VFD drive generated harmonics, and to reduce motor operating temperature.

Single Phase Applications:

RL reactors may also be sized to protect single phase drives. Please see MTE Application

Note: [How to Use a 3-Phase Line Reactor for a Single-Phase Application](#) for details.

NOTE: For inverters feeding isolation transformers select a reactor with a current rating equal to or greater than that of the transformer primary current.

Please verify information below for proper selection:

- Line Voltage and Frequency:** Input voltage 208V-690V 50/60 Hz (3-phase); 120V-600V 50/60 Hz (1-phase). See Table 3-1: Performance Specifications (p5) for specification.
- Current Rating:** Support for 1 Amp – 1500 Amps.
- Performance:** See Table 3-1: Performance Specifications (p5) for specification.
- Altitude:** 3,300 feet above sea level without derating. See Figure 3-1: Altitude Derating Curve (p7) for derating information.
- Enclosure Type:** Open Panel, NEMA 1/2 & NEMA 3R, see Enclosures (p4) for enclosure descriptions.
- Temperature:** See Table 3-1: Performance Specifications (p5) for operating temperature information and Figure 3-2: Temperature Derating (p7) for derating information.
- Refer to Article 430 Table 430.91 of the National Electrical code for the selection of the appropriate enclosure Type Number for your application.

Understanding the RL Line/Load Reactor Part Number:

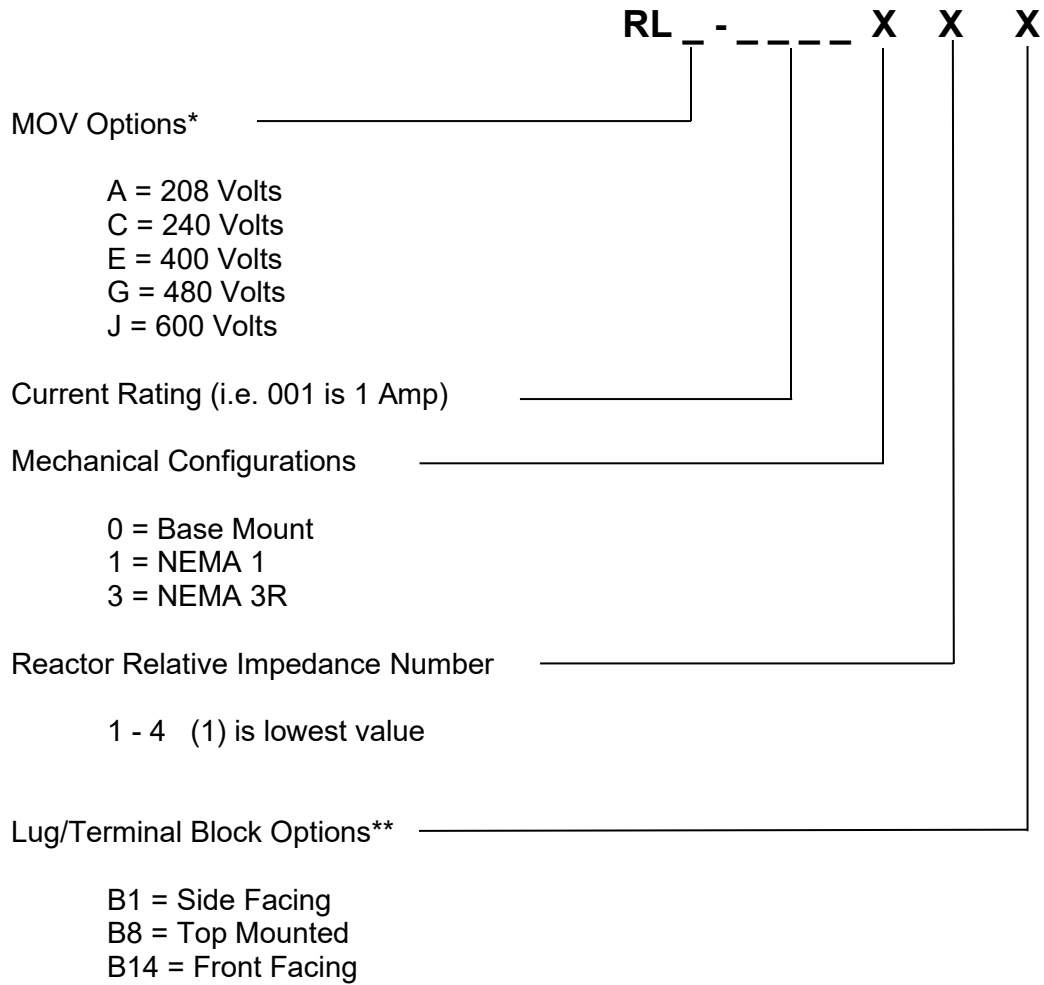

RL Line/Load Reactor OPTIONS:

* **MOV Option** – Adding Metal Oxide Varistors (MOV) can help prevent damage to reactors and variable frequency drives (VFD’s) when large spikes in transient voltage occur.

** **B1 & B14 Lug Orientation Option** – If the current RL part lug orientation does not work for installation; a modification can be made to adjust the lug to be either Side Facing or Front Facing. To signify the change, add either B1 or B14 to the end of the RL part number.

** **B8 Terminal Block Option** – If the current RL front mounted terminal block does not work for installation, a modification can be made to adjust a terminal block to be Top Mounted. To signify the change, add B8 to the end of the RL part number. **(Note: Terminal blocks are only available on reactors 45 Amps and below. Contact MTE for additional information.)**

Lug Option Details:

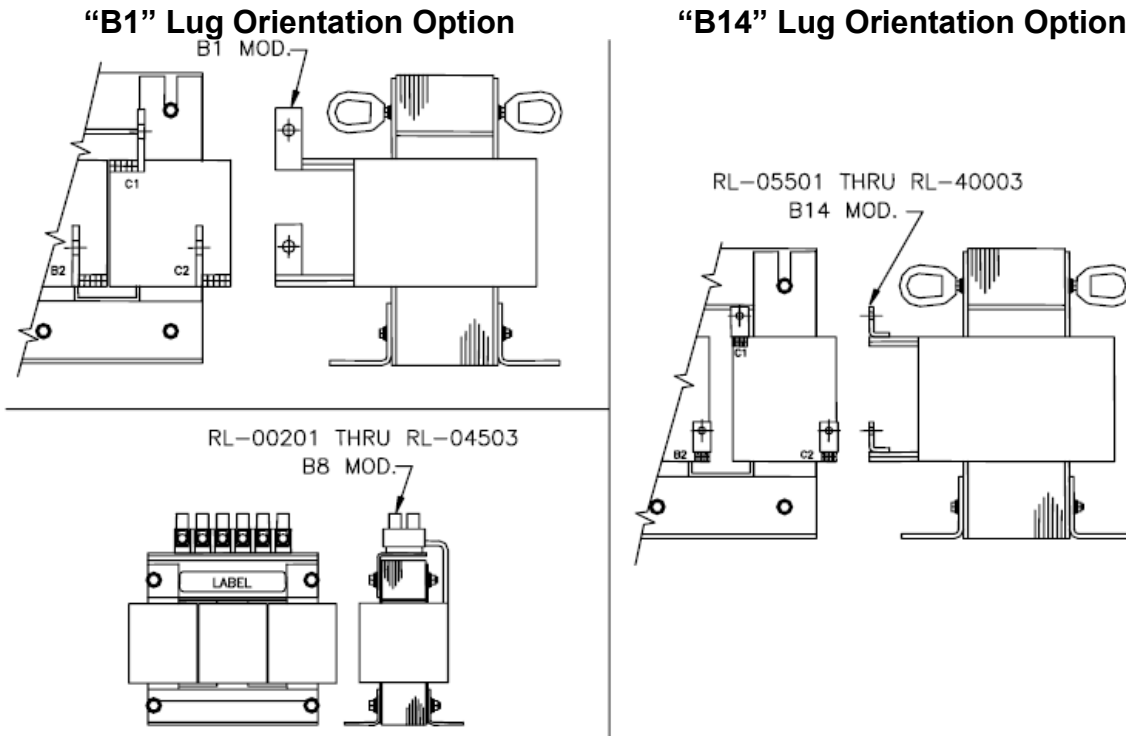

“B8” Terminal Block Modification

RL Line/Load Reactors 120V – 600V Single Phase Part Number Selection Tables

Table 4-1: RL Reactors 120V – 600V – Single Phase

Motor		% Impedance	Input Voltage & Hz						
KW	HP		120V 60Hz	208V 60Hz	240V 60Hz	240V 50Hz	400V 50Hz	480V 60Hz	600V 60Hz
0.18	0.25	5%	RL-01801	RL-00204	RL-00402	RL-00403	RL-00103	RL-00203	RL-00102
0.25	0.33	5%	RL-01801	RL-00803	RL-00402	RL-00402	RL-00203	RL-00202	RL-00103
0.37	0.5	5%	RL-01201	RL-00802	RL-00803	RL-00803	RL-00201	RL-00202	RL-00202
0.55	0.75	5%	RL-01801	RL-01202	RL-00802	RL-00802	RL-00404	RL-00404	RL-00202
0.75	1	5%	RL-01801	RL-00801	RL-01202	RL-00802	RL-00403	RL-00403	RL-00404
1.1	1.5	5%	RL-02501	RL-01201	RL-01201	RL-01802	RL-00803	RL-00803	RL-00403
1.5	2	5%	RL-03501	RL-01201	RL-01201	RL-01802	RL-00803	RL-00803	RL-00804
2.2	3	5%	RL-05501	RL-01801	RL-01801	RL-02502	RL-01203	RL-01203	RL-00803
3.7	5	5%	RL-10001	RL-03501	RL-02501	RL-03502	RL-01803	RL-01803	RL-01203
5	7.5	5%	RL-16001	RL-04501	RL-04501	RL-03501	RL-02503	RL-02503	RL-01803
7.5	10	5%	RL-20001B14	RL-05501	RL-04501	RL-05502	RL-03502	RL-02502	RL-02503
11	15	5%	-	RL-08001	RL-08001	RL-10002	RL-04502	RL-04502	RL-03503
15	20	5%	-	RL-10001	RL-10001	RL-13002	RL-05502	RL-05503	RL-04503
18.5	25	5%	-	RL-13001	RL-13001	RL-13002	RL-08002	RL-08003	RL-05503
22	30	5%	-	RL-16001	RL-16002	RL-16002	RL-08002	RL-08002	RL-05503
30	40	5%	-	RL-20001B14	RL-20002B14	RL-20002B14	RL-10002	RL-10002	RL-08003
37.5	50	5%	-	RL-25001B14	RL-25002B14	RL-25002B14	RL-13003	RL-13003	RL-10003
45	60	5%	-	RL-32001B14	RL-32002B14	RL-32002B14	RL-16003	RL-16003	RL-13003
55	75	5%	-	RL-40001B14	RL-32001B14	RL-40002B14	RL-20003B14	RL-20003B14	RL-13003
75	100	5%	-	RL-50001B14	RL-40001B14	RL-50002	RL-25003B14	RL-25003B14	RL-20003B14
93	125	5%	-	-	-	-	-	RL-32003B14	RL-25003B14
112	150	5%	-	-	-	-	-	RL-40003B14	RL-25003B14
150	200	5%	-	-	-	-	-	RL-40003B14	RL-32003B14

See [Technical and Mechanical Tables](#) for detailed data.

RL Line/Load Reactors 208 Volts, 60Hz Part Number Selection Tables

Table 4-2: RL Reactors 208V – 3-Phase

Motor		% Impedance	MTE Part Number & Enclosure Type		
			Open	NEMA 1/2	NEMA 3R
0.18	0.25	3%	RL-00204	RL-00214	RL-00234
		5%	RL-00201	RL-00211	RL-00231
0.25	0.33	3%	RL-00204	RL-00214	RL-00234
		5%	RL-00403	RL-00413	RL-00433
0.37	0.5	3%	RL-00401	RL-00411	RL-00431
		5%	RL-00402	RL-00412	RL-00432
0.55	0.75	3%	RL-00401	RL-00411	RL-00431
		5%	RL-00803	RL-00813	RL-00833
0.75	1	3%	RL-00801	RL-00811	RL-00831
		5%	RL-00802	RL-00812	RL-00832
1.1	1.5	3%	RL-00801	RL-00811	RL-00831
		5%	RL-00802	RL-00812	RL-00832
1.5	2	3%	RL-00801	RL-00811	RL-00831
		5%	RL-01202	RL-01212	RL-01232
2.2	3	3%	RL-01801	RL-01811	RL-01831
		5%	RL-01802	RL-01812	RL-01832
3.7	5	3%	RL-02501	RL-02511	RL-02531
		5%	RL-02502	RL-02512	RL-02532
5	7.5	3%	RL-03501	RL-03511	RL-03531
		5%	RL-03502	RL-03512	RL-03532
7.5	10	3%	RL-05501	RL-05511	RL-05531
		5%	RL-05502	RL-05512	RL-05532
11	15	3%	RL-05501	RL-05511	RL-05531
		5%	RL-04501	RL-04511	RL-04531
15	20	3%	RL-08001	RL-08011	RL-08031
		5%	RL-05501	RL-05511	RL-05531
18.5	25	3%	RL-10001	RL-10011	RL-10031
		5%	RL-08001	RL-08011	RL-08031

See [Technical and Mechanical Tables](#) for detailed data.

RL Line/Load Reactors 208 Volts, 60Hz Part Number Selection Tables

Table 4-3: RL Reactors 208V – 3-Phase

Motor		% Impedance	MTE Part Number & Enclosure Type		
			Open	NEMA 1/2	NEMA 3R
KW	HP				
22	30	3%	RL-10001	RL-10011	RL-10031
		5%	RL-13002	RL-13012	RL-13032
30	40	3%	RL-13001	RL-13011	RL-13031
		5%	RL-16002	RL-16012	RL-16032
37.5	50	3%	RL-16001	RL-16011	RL-16031
		5%	RL-20002B14	RL-20012B14	RL-20032B14
45	60	3%	RL-20001B14	RL-20011B14	RL-20031B14
		5%	RL-20002B14	RL-20012B14	RL-20032B14
55	75	3%	RL-25001B14	RL-25011B14	RL-25031B14
		5%	RL-25002B14	RL-25012B14	RL-25032B14
75	100	3%	RL-32001B14	RL-32011B14	RL-32031B14
		5%	RL-32002B14	RL-32012B14	RL-32032B14
93	125	3%	RL-40001B14	RL-40011B14	RL-40031B14
		5%	RL-40002B14	RL-40012B14	RL-40032B14
112	150	3%	RL-50001B14	RL-50011B14	RL-50031B14
		5%	RL-50002	RL-50012	RL-50032
150	200	3%	RL-60001	RL-60011	RL-60031
		5%	RL-75002	RL-75012	RL-75032
187	250	3%	RL-75001	RL-75011	RL-75031
		5%	RL-75002	RL-75012	RL-75032
225	300	3%	RL-85001B14	RL-85011B14	RL-85031B14
		5%	RL-90002B14	RL-90012B14	RL-90032B14
262	350	3%	RL-100001B14	RL-100011B14	RL-100031B14
		5%	RL-100002B14	RL-100012B14	RL-100032B14
300	400	3%	RL-120001B14	RL-120011B14	RL-120031B14
		5%	RL-120002B14	RL-120012B14	RL-120032B14
375	500	3%	RL-140001	RL-140011	RL-140031
		5%	RL-150002	RL-150012	RL-150032

See [Technical and Mechanical Tables](#) for detailed data.

RL Line/Load Reactors 240 Volts, 60Hz Part Number Selection Tables

Table 4-4: RL Reactors 240V – 3-Phase

Motor		% Impedance	MTE Part Number & Enclosure Type		
			Open	NEMA 1/2	NEMA 3R
KW	HP				
0.18	0.25	3%	RL-00204	RL-00214	RL-00234
		5%	RL-00201	RL-00211	RL-00231
0.25	0.33	3%	RL-00204	RL-00214	RL-00234
		5%	RL-00201	RL-00211	RL-00231
0.37	0.5	3%	RL-00402	RL-00412	RL-00432
		5%	RL-00403	RL-00413	RL-00433
0.55	0.75	3%	RL-00401	RL-00411	RL-00431
		5%	RL-00402	RL-00412	RL-00432
0.75	1	3%	RL-00802	RL-00812	RL-00832
		5%	RL-00803	RL-00813	RL-00833
1.1	1.5	3%	RL-00801	RL-00811	RL-00831
		5%	RL-00802	RL-00812	RL-00832
1.5	2	3%	RL-00801	RL-00811	RL-00831
		5%	RL-00802	RL-00812	RL-00832
2.2	3	3%	RL-01201	RL-01211	RL-01231
		5%	RL-01202	RL-01212	RL-01232
3.7	5	3%	RL-01801	RL-01811	RL-01831
		5%	RL-02502	RL-02512	RL-02532
5	7.5	3%	RL-02501	RL-02511	RL-02531
		5%	RL-03502	RL-03512	RL-03532
7.5	10	3%	RL-03501	RL-03511	RL-03531
		5%	RL-03502	RL-03512	RL-03532
11	15	3%	RL-04501	RL-04511	RL-04531
		5%	RL-05502	RL-05512	RL-05532
15	20	3%	RL-05501	RL-05511	RL-05531
		5%	RL-08002	RL-08012	RL-08032
18.5	25	3%	RL-08001	RL-08011	RL-08031
		5%	RL-10001	RL-10011	RL-10031

See [Technical and Mechanical Tables](#) for detailed data.

RL Line/Load Reactors 240 Volts, 60Hz Part Number Selection Tables

Table 4-5: RL Reactors 240V – 3-Phase

Motor		% Impedance	MTE Part Number & Enclosure Type		
			Open	NEMA 1/2	NEMA 3R
KW	HP				
22	30	3%	RL-10001	RL-10011	RL-10031
		5%	RL-08001	RL-08011	RL-08031
30	40	3%	RL-13001	RL-13011	RL-13031
		5%	RL-13002	RL-13012	RL-13032
37.5	50	3%	RL-13001	RL-13011	RL-13031
		5%	RL-16002	RL-16012	RL-16032
45	60	3%	RL-16001	RL-16011	RL-16031
		5%	RL-16002	RL-16012	RL-16032
55	75	3%	RL-20001B14	RL-20011B14	RL-20031B14
		5%	RL-20002B14	RL-20012B14	RL-20032B14
75	100	3%	RL-25001B14	RL-25011B14	RL-25031B14
		5%	RL-25002B14	RL-25012B14	RL-25032B14
93	125	3%	RL-32001B14	RL-32011B14	RL-32031B14
		5%	RL-40002B14	RL-40012B14	RL-40032B14
112	150	3%	RL-40001B14	RL-40011B14	RL-40031B14
		5%	RL-40002B14	RL-40012B14	RL-40032B14
150	200	3%	RL-50001B14	RL-50011B14	RL-50031B14
		5%	RL-60002	RL-60012	RL-60032
187	250	3%	RL-60001	RL-60011	RL-60031
		5%	RL-75002	RL-75012	RL-75032
225	300	3%	RL-75001	RL-75011	RL-75031
		5%	RL-75002	RL-75012	RL-75032
262	350	3%	RL-85001B14	RL-85011B14	RL-85031B14
		5%	RL-85002B14	RL-85012B14	RL-85032B14
300	400	3%	RL-100001B14	RL-100011B14	RL-100031B14
		5%	RL-100002B14	RL-100012B14	RL-100032B14
375	500	3%	RL-120001B14	RL-120011B14	RL-120031B14
		5%	RL-140002	RL-140102	RL-140302

See [Technical and Mechanical Tables](#) for detailed data.

RL Line/Load Reactors 400 Volts, 50Hz Part Number Selection Tables

Table 4-6: RL Reactors 400V – 3-Phase

Motor		% Impedance	MTE Part Number & Enclosure Type		
			Open	NEMA 1/2	NEMA 3R
KW	HP				
0.18	0.25	3%	RL-00103	RL-00113	RL-00133
		5%	RL-00102	RL-00112	RL-00132
0.25	0.33	3%	RL-00103	RL-00113	RL-00133
		5%	RL-00102	RL-00112	RL-00132
0.37	0.5	3%	RL-00202	RL-00212	RL-00232
		5%	RL-00203	RL-00213	RL-00233
0.55	0.75	3%	RL-00201	RL-00211	RL-00231
		5%	RL-00202	RL-00212	RL-00232
0.75	1	3%	RL-00403	RL-00413	RL-00433
		5%	RL-00202	RL-00212	RL-00232
1.1	1.5	3%	RL-00402	RL-00412	RL-00432
		5%	RL-00404	RL-00414	RL-00434
1.5	2	3%	RL-00402	RL-00412	RL-00432
		5%	RL-00403	RL-00413	RL-00433
2.2	3	3%	RL-00803	RL-00813	RL-00833
		5%	RL-00804	RL-00814	RL-00834
3.7	5	3%	RL-00802	RL-00812	RL-00832
		5%	RL-00803	RL-00813	RL-00833
5	7.5	3%	RL-01202	RL-01212	RL-01232
		5%	RL-01203	RL-01213	RL-01233
7.5	10	3%	RL-01802	RL-01812	RL-01832
		5%	RL-01803	RL-01813	RL-01833
11	15	3%	RL-02502	RL-02512	RL-02532
		5%	RL-02503	RL-02513	RL-02533
15	20	3%	RL-03502	RL-03512	RL-03532
		5%	RL-03503	RL-03513	RL-03533
18.5	25	3%	RL-04502	RL-04512	RL-04532
		5%	RL-04503	RL-04513	RL-04533
22	30	3%	RL-04502	RL-04512	RL-04532
		5%	RL-05503	RL-05513	RL-05533
30	40	3%	RL-08002	RL-08012	RL-08032
		5%	RL-08003	RL-08013	RL-08033

See [Technical and Mechanical Tables](#) for detailed data.

RL Line/Load Reactors 400 Volts, 50Hz Part Number Selection Tables

Table 4-7: RL Reactors 400V – 3-Phase

Motor		% Impedance	MTE Part Number & Enclosure Type		
			Open	NEMA 1/2	NEMA 3R
37.5	50	3%	RL-08002	RL-08012	RL-08032
		5%	RL-10003	RL-10013	RL-10033
45	60	3%	RL-10002	RL-10012	RL-10032
		5%	RL-10003	RL-10013	RL-10033
55	75	3%	RL-13002	RL-13012	RL-13032
		5%	RL-13003	RL-13013	RL-13033
75	100	3%	RL-16002	RL-16012	RL-16032
		5%	RL-16003	RL-16013	RL-16033
93	125	3%	RL-20002B14	RL-20012B14	RL-20032B14
		5%	RL-20003B14	RL-20013B14	RL-20033B14
112	150	3%	RL-20002B14	RL-20012B14	RL-20032B14
		5%	RL-20003B14	RL-20013B14	RL-20033B14
150	200	3%	RL-32002B14	RL-32012B14	RL-32032B14
		5%	RL-32003B14	RL-32013B14	RL-32033B14
187	250	3%	RL-40002B14	RL-40012B14	RL-40032B14
		5%	RL-40003B14	RL-40013B14	RL-40033B14
225	300	3%	RL-40002B14	RL-40012B14	RL-40032B14
		5%	RL-40003B14	RL-40013B14	RL-40033B14
262	350	3%	RL-50002	RL-50012	RL-50032
		5%	RL-50003	RL-50013	RL-50033
300	400	3%	RL-60002	RL-60012	RL-60032
		5%	RL-60003	RL-60013	RL-60033
375	500	3%	RL-75002	RL-75012	RL-75032
		5%	RL-75003	RL-75013	RL-75033
450	600	3%	RL-85002B14	RL-85012B14	RL-85032B14
		5%	RL-85003B14	RL-85013B14	RL-85033B14
550	700	3%	RL-90002B14	RL-90012B14	RL-90032B14
		5%	RL-90003B14	RL-90013B14	RL-90033B14
600	800	3%	RL-120002B14	RL-120012B14	RL-120032B14
		5%	RL-120003B14	RL-120013B14	RL-120033B14

See [Technical and Mechanical Tables](#) for detailed data.

RL Line/Load Reactors 480 Volts, 60Hz Part Number Selection Tables

Table 4-8: RL Reactors 480V – 3-Phase

Motor		% Impedance	MTE Part Number & Enclosure Type		
			Open	NEMA 1/2	NEMA 3R
KW	HP				
0.18	0.25	3%	RL-00103	RL-00113	RL-00133
		5%	RL-00102	RL-00112	RL-00132
0.25	0.33	3%	RL-00103	RL-00113	RL-00133
		5%	RL-00102	RL-00112	RL-00132
0.37	0.5	3%	RL-00104	RL-00114	RL-00134
		5%	RL-00103	RL-00113	RL-00133
0.55	0.75	3%	RL-00201	RL-00211	RL-00231
		5%	RL-00202	RL-00212	RL-00232
0.75	1	3%	RL-00201	RL-00211	RL-00231
		5%	RL-00202	RL-00212	RL-00232
1.1	1.5	3%	RL-00402	RL-00412	RL-00432
		5%	RL-00404	RL-00414	RL-00434
1.5	2	3%	RL-00402	RL-00412	RL-00432
		5%	RL-00403	RL-00413	RL-00433
2.2	3	3%	RL-00803	RL-00813	RL-00833
		5%	RL-00804	RL-00814	RL-00834
3.7	5	3%	RL-00802	RL-00812	RL-00832
		5%	RL-00803	RL-00813	RL-00833
5	7.5	3%	RL-01202	RL-01212	RL-01232
		5%	RL-01203	RL-01213	RL-01233
7.5	10	3%	RL-01802	RL-01812	RL-01832
		5%	RL-01803	RL-01813	RL-01833
11	15	3%	RL-02502	RL-02512	RL-02532
		5%	RL-02503	RL-02513	RL-02533
15	20	3%	RL-03502	RL-03512	RL-03532
		5%	RL-03503	RL-03513	RL-03533
18.5	25	3%	RL-03502	RL-03512	RL-03532
		5%	RL-03503	RL-03513	RL-03533
22	30	3%	RL-04502	RL-04512	RL-04532
		5%	RL-05503	RL-05513	RL-05533
30	40	3%	RL-05502	RL-05512	RL-05532
		5%	RL-05503	RL-05513	RL-05533

See [Technical and Mechanical Tables](#) for detailed data.

RL Line/Load Reactors 480 Volts, 60Hz Part Number Selection Tables

Table 4-9: RL Reactors 480V – 3-Phase

Motor		% Impedance	MTE Part Number & Enclosure Type		
			Open	NEMA 1/2	NEMA 3R
KW	HP				
37.5	50	3%	RL-08002	RL-08012	RL-08032
		5%	RL-08003	RL-08013	RL-08033
45	60	3%	RL-10002	RL-10012	RL-10032
		5%	RL-10003	RL-10013	RL-10033
55	75	3%	RL-10002	RL-10012	RL-10032
		5%	RL-10003	RL-10013	RL-10033
75	100	3%	RL-13002	RL-13012	RL-13032
		5%	RL-13003	RL-13013	RL-13033
93	125	3%	RL-16002	RL-16012	RL-16032
		5%	RL-16003	RL-16013	RL-16033
112	150	3%	RL-20002B14	RL-20012B14	RL-20032B14
		5%	RL-20003B14	RL-20013B14	RL-20033B14
150	200	3%	RL-25002B14	RL-25012B14	RL-25032B14
		5%	RL-25003B14	RL-25013B14	RL-25033B14
187	250	3%	RL-32002B14	RL-32012B14	RL-32032B14
		5%	RL-32003B14	RL-32013B14	RL-32033B14
225	300	3%	RL-40002B14	RL-40012B14	RL-40032B14
		5%	RL-40003B14	RL-40013B14	RL-40033B14
262	350	3%	RL-50002	RL-50012	RL-50032
		5%	RL-50003	RL-50013	RL-50033
300	400	3%	RL-50002	RL-50012	RL-50032
		5%	RL-50003	RL-50013	RL-50033
375	500	3%	RL-60002	RL-60012	RL-60032
		5%	RL-60003	RL-60013	RL-60033
450	600	3%	RL-75002	RL-75012	RL-75032
		5%	RL-75003	RL-75013	RL-75033
550	700	3%	RL-85002B14	RL-85012B14	RL-85032B14
		5%	RL-85003B14	RL-85013B14	RL-85033B14
600	800	3%	RL-100002B14	RL-100012B14	RL-100032B14
		5%	RL-100003B14	RL-100013B14	RL-100033B14

See [Technical and Mechanical Tables](#) for detailed data.

RL Line/Load Reactors 600 Volts, 60Hz Part Number Selection Tables

Table 4-10: RL Reactors 600V – 3-Phase

Motor		% Impedance	MTE Part Number & Enclosure Type		
			Open	NEMA 1/2	NEMA 3R
KW	HP				
0.18	0.25	3%	RL-00102	RL-00112	RL-00132
		5%	RL-00101	RL-00111	RL-00131
0.25	0.33	3%	RL-00103	RL-00113	RL-00133
		5%	RL-00102	RL-00112	RL-00132
0.37	0.5	3%	RL-00103	RL-00113	RL-00133
		5%	RL-00102	RL-00112	RL-00132
0.55	0.75	3%	RL-00202	RL-00212	RL-00232
		5%	RL-00203	RL-00213	RL-00233
0.75	1	3%	RL-00202	RL-00212	RL-00232
		5%	RL-00203	RL-00213	RL-00233
1.1	1.5	3%	RL-00201	RL-00211	RL-00231
		5%	RL-00202	RL-00212	RL-00232
1.5	2	3%	RL-00403	RL-00413	RL-00433
		5%	RL-00404	RL-00414	RL-00434
2.2	3	3%	RL-00402	RL-00412	RL-00432
		5%	RL-00404	RL-00414	RL-00434
3.7	5	3%	RL-00803	RL-00813	RL-00833
		5%	RL-00804	RL-00814	RL-00834
5	7.5	3%	RL-01202	RL-01212	RL-01232
		5%	RL-01203	RL-01213	RL-01233
7.5	10	3%	RL-01202	RL-01212	RL-01232
		5%	RL-01203	RL-01213	RL-01233
11	15	3%	RL-01802	RL-01812	RL-01832
		5%	RL-01803	RL-01813	RL-01833
15	20	3%	RL-02502	RL-02512	RL-02532
		5%	RL-02503	RL-02513	RL-02533
18.5	25	3%	RL-02502	RL-02512	RL-02532
		5%	RL-02503	RL-02513	RL-02533
22	30	3%	RL-03502	RL-03512	RL-03532
		5%	RL-03503	RL-03513	RL-03533
30	40	3%	RL-04502	RL-04512	RL-04532
		5%	RL-04503	RL-04513	RL-04533

See [Technical and Mechanical Tables](#) for detailed data.

RL Line/Load Reactors 600 Volts, 60Hz Part Number Selection Tables

Table 4-11: RL Reactors 600V – 3-Phase

Motor		% Impedance	MTE Part Number & Enclosure Type		
			Open	NEMA 1/2	NEMA 3R
KW	HP				
37.5	50	3%	RL-05502	RL-05512	RL-05532
		5%	RL-05503	RL-05513	RL-05533
45	60	3%	RL-08002	RL-08012	RL-08032
		5%	RL-08003	RL-08013	RL-08033
55	75	3%	RL-08002	RL-08012	RL-08032
		5%	RL-08003	RL-08013	RL-08033
75	100	3%	RL-10002	RL-10012	RL-10032
		5%	RL-10003	RL-10013	RL-10033
93	125	3%	RL-13002	RL-13012	RL-13032
		5%	RL-13003	RL-13013	RL-13033
112	150	3%	RL-16002	RL-16012	RL-16032
		5%	RL-16003	RL-16013	RL-16033
150	200	3%	RL-20002B14	RL-20012B14	RL-20032B14
		5%	RL-20003B14	RL-20013B14	RL-20033B14
187	250	3%	RL-25002B14	RL-25012B14	RL-25032B14
		5%	RL-25003B14	RL-25013B14	RL-25033B14
225	300	3%	RL-32002B14	RL-32012B14	RL-32032B14
		5%	RL-32003B14	RL-32013B14	RL-32033B14
262	350	3%	RL-32002B14	RL-32012B14	RL-32032B14
		5%	RL-32003B14	RL-32013B14	RL-32033B14
300	400	3%	RL-40002B14	RL-40012B14	RL-40032B14
		5%	RL-40003B14	RL-40013B14	RL-40033B14
375	500	3%	RL-50002	RL-50012	RL-50032
		5%	RL-50003	RL-50013	RL-50033
450	600	3%	RL-60002	RL-60012	RL-60032
		5%	RL-60003	RL-60013	RL-60033
550	700	3%	RL-75002	RL-75012	RL-75032
		5%	RL-75003	RL-75013	RL-75033
600	800	3%	RL-75002	RL-75012	RL-75032
		5%	RL-75003	RL-75013	RL-75033

See [Technical and Mechanical Tables](#) for detailed data.

RL Line/Load Reactors 690 Volts, 50Hz Part Number Selection Tables

Table 4-12: RL Reactors 690V – 3-Phase

Motor		% Impedance	MTE Part Number & Enclosure Type		
			Open	NEMA 1/2	NEMA 3R
KW	HP				
2.2	3	3%	RL-00403	RL-00413	RL-00433
		5%	RL-00404	RL-00414	RL-00434
3.7	5	3%	RL-00803	RL-00813	RL-00833
		5%	RL-00804	RL-00814	RL-00834
5	7.5	3%	RL-00803	RL-00813	RL-00833
		5%	RL-00804	RL-00814	RL-00834
7.5	10	3%	RL-01202	RL-01212	RL-01232
		5%	RL-01203	RL-01213	RL-01233
11	15	3%	RL-01202	RL-01212	RL-01232
		5%	RL-01203	RL-01213	RL-01233
15	20	3%	RL-01802	RL-01812	RL-01832
		5%	RL-01803	RL-01813	RL-01833
18.5	25	3%	RL-02502	RL-02512	RL-02532
		5%	RL-02503	RL-02513	RL-02533
22	30	3%	RL-02502	RL-02512	RL-02532
		5%	RL-02503	RL-02513	RL-02533
30	40	3%	RL-03502	RL-03512	RL-03532
		5%	RL-03503	RL-03513	RL-03533
37.5	50	3%	RL-04502	RL-04512	RL-04532
		5%	RL-04503	RL-04513	RL-04533
45	60	3%	RL-05502	RL-05512	RL-05532
		5%	RL-04502	RL-04512	RL-04532
55	75	3%	RL-05502	RL-05512	RL-05532
		5%	RL-05503	RL-05513	RL-05533

See [Technical and Mechanical Tables](#) for detailed data.

RL Line/Load Reactors 690 Volts, 50Hz Part Number Selection Tables

Table 4-13: RL Reactors 690V – 3-Phase

Motor		% Impedance	MTE Part Number & Enclosure Type		
			Open	NEMA 1/2	NEMA 3R
KW	HP				
75	100	3%	RL-08002	RL-08012	RL-08032
		5%	RL-08003	RL-08013	RL-08033
93	125	3%	RL-10002	RL-10012	RL-10032
		5%	RL-10003	RL-10013	RL-10033
112	150	3%	RL-13002	RL-13012	RL-13032
		5%	RL-13003	RL-13013	RL-13033
150	200	3%	RL-16002	RL-16012	RL-16032
		5%	RL-16003	RL-16013	RL-16033
187	250	3%	RL-20002B14	RL-20012B14	RL-20032B14
		5%	RL-20003B14	RL-20013B14	RL-20033B14
225	300	3%	RL-25002B14	RL-25012B14	RL-25032B14
		5%	RL-25003B14	RL-25013B14	RL-25033B14
262	350	3%	RL-25002B14	RL-25012B14	RL-25032B14
		5%	RL-25003B14	RL-25013B14	RL-25033B14
300	400	3%	RL-32002B14	RL-32012B14	RL-32032B14
		5%	RL-32003B14	RL-32013B14	RL-32033B14
375	500	3%	RL-40002B14	RL-40012B14	RL-40032B14
		5%	RL-40003B14	RL-40013B14	RL-40033B14
450	600	3%	RL-40002B14	RL-40012B14	RL-40032B14
		5%	RL-50003	RL-50013	RL-50033
550	700	3%	RL-50002	RL-50012	RL-50032
		5%	RL-50003	RL-50013	RL-50033
600	800	3%	RL-60002	RL-60012	RL-60032
		5%	RL-60003	RL-60013	RL-60033

See [Technical and Mechanical Tables](#) for detailed data.

RL Line/Load Reactors Open Dimension Reference

Use the reactor outline below for reference with the Technical and Mechanical Specification tables on the following pages.

Dimensions A, B, and C show overall Width, Height, and Depth respectively.

Dimensions D, E, and F are the mounting pattern.

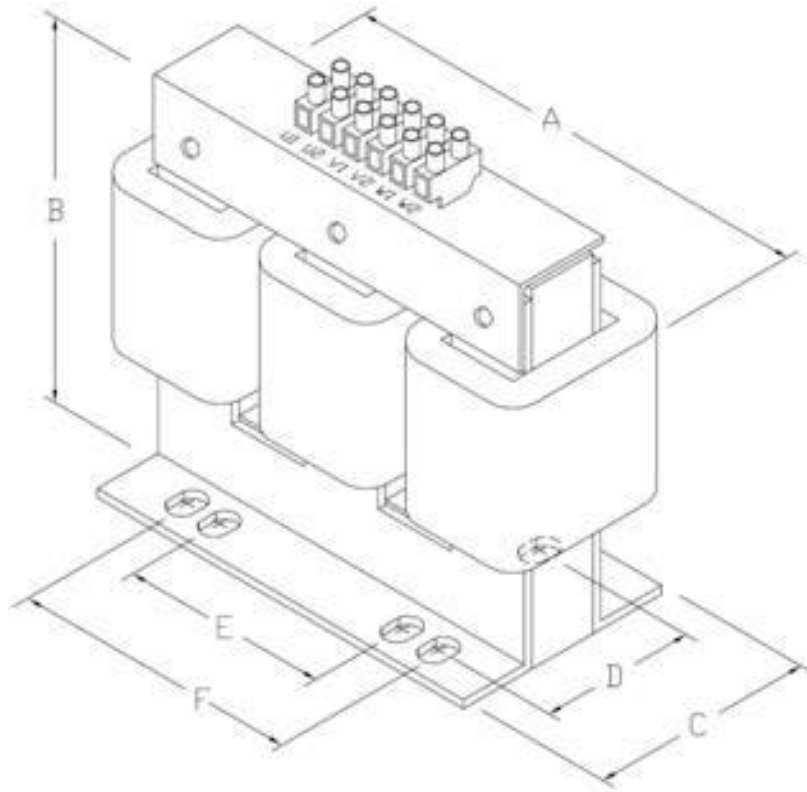

RL Line/Load Reactors Technical and Mechanical Specifications

Table 4-14: RL Reactors Open Panel Technical Specifications

MTE Part Number	Amps Rating	Inductance mh	Watts Loss	A	B	C	D	E	F	Approx Weight
				in./mm	in./mm	in./mm	in./mm	in./mm	in./mm	Lbs./Kg
RL-00101	1	100	14.1	4.2/ 106.7	4/ 101.6	3/ 76.2	2.4/ 61	1.4/ 37	2.6/ 65	4/ 1.8
RL-00102	1	50	14.8	4.4/ 111.8	4.1/ 104.1	2.8/ 7.1	2/ 50	1.4/ 37	2.6/ 65	4/ 1.8
RL-00103	1	36	12.0	4.4/ 111.8	4.1/ 104.1	2.8/ 7.1	2/ 50	1.4/ 37	2.6/ 65	4/ 1.8
RL-00104	1	18	8.0	4.4/ 111.8	4.1/ 104.1	2.8/ 7.1	2/ 50	1.4/ 37	2.6/ 65	4/ 1.8
RL-00201	2	12	7.5	4.2/ 106.7	4/ 101.6	2.6/ 66	2/ 50	1.4/ 37	2.6/ 65	4/ 1.8
RL-00202	2	20	11.3	4.2/ 106.7	4/ 101.6	2.6/ 66	2/ 50	1.4/ 37	2.6/ 65	4/ 1.8
RL-00203	2	32	16	4.2/ 106.7	4/ 101.6	2.6/ 66	2/ 50	1.4/ 37	2.6/ 65	4/ 1.8
RL-00204	2	6	10.7	4.2/ 106.7	4/ 101.6	2.6/ 66	1.7/ 44	1.4/ 37	2.6/ 65	3/ 1.4
RL-00401	4	3	14.5	4.2/ 106.7	4/ 101.6	2.6/ 66	2/ 50	1.4/ 37	2.6/ 65	4/ 1.8
RL-00402	4	6.5	20	4.2/ 106.7	4/ 101.6	2.6/ 66	2/ 50	1.4/ 37	2.6/ 65	4/ 1.8
RL-00403	4	9	20	4.2/ 106.7	4/ 101.6	3/ 76.2	2.4/ 60	1.4/ 37	2.6/ 65	5/ 2.3
RL-00404	4	12	21	4.2/ 106.7	4/ 101.6	3.3/ 83.8	2.6/ 66	1.4/ 37	2.6/ 65	6/ 2.7
RL-00801	8	1.5	19.5	5.9/ 149.9	4.6/ 116.8	2.9/ 73.7	2.1/ 53	2/ 51	3/ 76.2	7/ 3.2
RL-00802	8	3	29	5.9/ 149.9	4.6/ 116.8	2.9/ 73.7	2.1/ 53	2/ 51	3/ 76.2	8/ 3.6
RL-00803	8	5	25.3	5.9/ 149.9	4.7/ 119.4	3.3/ 83.8	2.6/ 67	2/ 51	3/ 76.2	11/ 5
RL-00804	8	7.5	28	5.9/ 149.9	4.7/ 119.4	3.3/ 83.8	2.5/ 63	2/ 51	3/ 76.2	13/ 5.9
RL-01201	12	1.25	26	5.9/ 149.9	5/ 127	3.2/ 81.3	2.1/ 53	2/ 51	3/ 76.2	9/ 4.1
RL-01202	12	2.5	31	5.9/ 149.9	5/ 127	3.2/ 81.3	2.1/ 53	2/ 51	3/ 76.2	10/ 4.5
RL-01203	12	4.2	41	5.9/ 149.9	5/ 127	3.8/ 96.5	2.8/ 70	2/ 51	3/ 76.2	18/ 8.2
RL-01801	18	0.8	36	5.9/ 149.9	5.1/ 129.5	3.2/ 81.3	2.1/ 54	2/ 51	3/ 76.2	9/ 4.1

For detailed drawings of each reactor, click on the “MTE Part Number”.

RL Line/Load Reactors Technical and Mechanical Specifications

Table 4-14: RL Reactors Open Panel Technical Specifications (continued)

MTE Part Number	Amps Rating	Inductance mh	Watts Loss	A	B	C	D	E	F	Approx Weight
				in./mm	in./mm	in./mm	in./mm	in./mm	in./mm	Lbs./Kg
RL-01802	18	1.5	43	5.9/ 149.9	5.1/ 129.5	3.5/ 88.9	2.5/ 63	2/ 51	3/ 76.2	12/ 5.4
RL-01803	18	2.5	43	7.1/ 180.3	5.7/ 144.8	3.7/ 94	2.6/ 66	3/ 76	3/ 76.2	16/ 7.3
RL-02501	25	0.5	48	7.1/ 180.3	5.7/ 144.8	3.4/ 86.7	2.4/ 60	3/ 76	3/ 76.2	11/ 5
RL-02502	25	1.2	52	7.1/ 180.3	5.8/ 147.3	3.4/ 86.7	2.4/ 60	3/ 76	3/ 76.2	14/ 6.4
RL-02503	25	1.8	61	7.1/ 180.3	5.8/ 147.3	4.2/ 106.7	3.1/ 79	3/ 76	3/ 76.2	20/ 9.1
RL-03501	35	0.4	49	7.1/ 180.3	5.7/ 144.8	3.7/ 94	2.6/ 66	3/ 76	3/ 76.2	14/ 6.4
RL-03502	35	0.8	54	7.1/ 180.3	5.8/ 147.3	3.7/ 94	2.8/ 70	3/ 76	3/ 76.2	16/ 7.3
RL-03503	35	1.2	54	8.9/ 226.1	7.2/ 182.9	4.6/ 116.8	3.2/ 80	3/ 76	4.3/ 108	26/ 11.8
RL-04501	45	0.3	54	8.9/ 226.1	7.1/ 180.3	4.6/ 116.8	3.2/ 80	3/ 76	4.3/ 108	22/ 10
RL-04502	45	0.7	62	8.9/ 226.1	7.2/ 182.9	4.6/ 116.8	3.2/ 80	3/ 76	4.3/ 108	26/ 11.8
RL-04503	45	1.2	65	8.9/ 226.1	7.3/ 185.4	5.1/ 129.5	3.7/ 93	3/ 76	4.3/ 108	34/ 15.4
RL-05501	55	0.25	64	9/ 228.6	6.9/ 175.3	5.3/ 134.6	3.2/ 80	3/ 76	4.3/ 108	24/ 109.
RL-05502	55	0.5	67	9/ 228.6	6.9/ 175.3	5.3/ 134.6	3.2/ 80	3/ 76	4.3/ 108	26/ 11.8
RL-05503	55	0.85	71	8.9/ 226.1	6.9/ 175.3	6.3/ 160	3.9/ 99	3/ 76	4.3/ 108	34/ 15.4
RL-08001	80	0.2	82	8.9/ 226.1	6.9/ 175.3	5.7/ 144.8	3.5/ 88	3.63/ 92	4.3/ 108	25/ 11.3
RL-08002	80	0.4	86	8.9/ 226.1	7.1/ 180.3	5.7/ 144.8	3.5/ 88	3.63/ 92	4.3/ 108	33/ 15
RL-08003	80	0.7	96	10.8/ 274.3	8.5/ 215.9	6.6/ 167.6	4.2/ 106	3.63/ 92	5.6/ 141.7	63/ 28.6
RL-10001	100	0.15	94	8.9/ 226.1	7/ 177.8	6/ 152.4	3.5/ 88	3.63/ 92	4.3/ 108	29/ 13.2
RL-10002	100	0.3	84	8.9/ 226.1	7/ 177.8	6.6/ 167.6	3.7/ 93	3.63/ 92	4.3/ 108	37/ 16.8
RL-10003	100	0.45	108	10.8/ 274.3	8.4/ 213.4	7.8/ 198.1	4.2/ 106	3.63/ 92	5.6/ 141.7	67/ 30.4

For detailed drawings of each reactor, click on the “MTE Part Number”.

RL Line/Load Reactors Technical and Mechanical Specifications

Table 4-14: RL Reactors Open Panel Technical Specifications (continued)

MTE Part Number	Amps Rating	Inductance mh	Watts Loss	A	B	C	D	E	F	Approx Weight
				in./mm	in./mm	in./mm	in./mm	in./mm	in./mm	Lbs./Kg
RL-13001	130	0.1	108	9.6/ 243.8	7.3/ 185.4	5.9/ 149.9	3.2/ 80	3/ 76	4.3/ 108	29/ 13.2
RL-13002	130	0.2	180	9.6/ 243.8	7.2/ 182.9	6/ 152.4	3.7/ 93	3.63/ 92	4.3/ 108	43/ 19.5
RL-13003	130	0.3	128	10.8/ 274.3	8.5/ 215.9	7.3/ 185.4	4.2/ 106	3.63/ 92	5.6/ 141.7	64/ 29
RL-16001	160	0.075	116	9.6/ 243.8	7.2/ 182.9	6/ 152.4	3.2/ 80	3.63/ 92	4.3/ 108	41/ 18.6
RL-16002	160	0.15	149	10.8/ 274.3	8.4/ 213.4	6.7/ 170.2	3.5/ 88	3.63/ 92	5.6/ 141.7	54/ 24.5
RL-16003	160	0.23	138	10.8/ 274.3	8.5/ 215.9	7.4/ 187	4.7/ 118	3.63/ 92	5.6/ 141.7	74/ 33.6
RL-20001B14	200	0.055	124	9.6/ 243.8	7.2/ 182.9	7.1/ 180.3	4.2/ 106	3.63/ 92	4.3/ 108	38/ 17.2
RL-20002B14	200	0.11	168	9.6/ 243.8	7.2/ 182.9	7.9/ 200.7	4.4/ 112	3.63/ 92	4.3/ 108	54/ 24.5
RL-20003B14	200	0.185	146	10.8/ 274.3	8.3/ 210.8	9.1/ 231.1	5.9/ 150	3.63/ 92	5.6/ 141.7	100/ 45.4
RL-25001B14	250	0.045	154	9.6/ 243.8	7/ 177.8	8.1/ 205.7	4.2/ 106	3.63/ 92	4.3/ 108	47/ 21.3
RL-25002B14	250	0.09	231	10.8/ 274.3	8.5/ 215.9	7.6/ 193	5.2/ 131	4.6/ 117	5.6/ 141.7	80/ 36.3
RL-25003B14	250	0.15	588	14.3/ 363.2	11.2/ 284.5	8.7/ 221	5.8/ 148	4.6/ 117	7.2/ 182.9	125/ 56.7
RL-32001B14	320	0.04	224	10.8/ 274.3	8.4/ 213.4	7.9/ 200.7	5.2/ 131	4.6/ 117	5.6/ 141.7	80/ 36.3
RL-32002B14	320	0.075	264	10.8/ 274.3	8.4/ 213.4	8.9/ 226.1	5.9/ 149	4.6/ 117	5.6/ 141.7	102/ 46.3
RL-32003B14	320	0.125	642	14.3/ 363.2	11.1/ 281.9	9.4/ 238.8	7.1/ 181	4.6/ 117	7.2/ 182.9	160/ 72.6
RL-40001B14	400	0.03	213	11/ 279.4	8.4/ 213.4	8.6/ 218.4	5.2/ 131	4.6/ 117	5.6/ 141.7	84/ 38.1
RL-40002B14	400	0.06	571	14.3/ 363.2	11.1/ 281.9	9.4/ 238.8	6.8/ 172	4.6/ 117	7.2/ 182.9	118/ 53.5
RL-40003B14	400	0.105	293	14.3/ 363.2	11.1/ 281.9	10.9/ 276.9	7.3/ 184	4.6/ 117	7.2/ 182.9	149/ 67.6
RL-50001B14	500	0.025	226	10.8/ 274.3	8.5/ 215.9	9.4/ 238.8	5.5/ 140	4.6/ 117	5.6/ 141.7	93/ 42.2
RL-50002	500	0.05	694	14.3/ 363.2	11.1/ 281.9	10.6/ 269.2	6.8/ 172	4.6/ 117	7.2/ 182.9	160/ 72.6

For detailed drawings of each reactor, click on the “MTE Part Number”.

RL Line/Load Reactors Technical and Mechanical Specifications

Table 4-14: RL Reactors Open Panel Technical Specifications (continued)

MTE Part Number	Amps Rating	Inductance mh	Watts Loss	A	B	C	D	E	F	Approx Weight
				in./mm	in./mm	in./mm	in./mm	in./mm	in./mm	Lbs./Kg
RL-50003	500	0.085	985	14.3/ 363.2	11.1/ 281.9	13/ 330.2	9.8/ 248	4.6/ 117	7.2/ 182.9	210/ 95.3
RL-60001	600	0.02	609	14.3/ 363.2	11.1/ 281.9	8.8/ 223.5	5.3/ 134	4.6/ 117	7.2/ 182.9	120/ 54.4
RL-60002	600	0.04	689	14.3/ 363.2	11.1/ 281.9	11/ 279.4	8/ 203	4.6/ 117	7.2/ 182.9	175/ 79.4
RL-60003	600	0.065	406	14.3/ 363.2	11.1/ 281.9	13.5/ 342.9	9.3/ 235	4.6/ 117	7.2/ 182.9	270/ 122.5
RL-75001	750	0.015	713	14.3/ 363.2	11.2/ 284.5	10.4/ 264.2	6.6/ 168	7.2/ 183	7.2/ 182.9	140/ 63.5
RL-75002	750	0.029	630	14.3/ 363.2	11.1/ 281.9	11.5/ 292.1	8/ 204	7.2/ 183	7.2/ 182.9	190/ 86.2
RL-75003	750	0.048	552	14/ 355.6	14.1/ 358.1	13/ 330.2	9.5/ 242	7.2/ 183	7.2/ 182.9	265/ 120.2
RL-85001B14	850	0.015	798	17.8/ 452.1	15.5/ 393.7	14.8/ 375.9	7.9/ 199.6	7.2/ 183	7.2/ 182.9	195/ 88.5
RL-85002B14	850	0.027	930	17.8/ 452.1	15.5/ 393.7	15.5/ 393.7	N/A	N/A	7.2/ 182.9	215/ 97.5
RL-85003B14	850	0.042	1133	17.8/ 452.1	15.8/ 401.3	17.5/ 444.5	N/A	N/A	7.2/ 182.9	315/ 142.9
RL-90001B14	900	0.014	655	16.2/ 411.5	14.4/ 365.8	13.8/ 350.5	N/A	N/A	7.2/ 182.9	195/ 88.5
RL-90002B14	900	0.025	1020	17/ 431.8	14.6/ 370.8	14.7/ 373.4	N/A	N/A	7.2/ 182.9	215/ 97.5
RL-90003B14	900	0.04	1365	17.8/ 452.1	15.8/ 401.3	17.1/ 434.3	N/A	N/A	7.2/ 182.9	315/ 142.9
RL-100001B14	1000	0.011	810	17/ 431.8	14.4/ 365.8	12.5/ 317.5	N/A	N/A	7.2/ 182.9	144/ 65.3
RL-100002B14	1000	0.022	1080	17/ 431.8	14.6/ 370.8	14.7/ 373.4	N/A	N/A	7.2/ 182.9	215/ 97.5
RL-100003B14	1000	0.038	1250	17/ 431.8	14.6/ 370.8	17.2/ 436.9	N/A	N/A	7.2/ 182.9	315/ 142.9
RL-120001B14	1200	0.009	870	17/ 431.8	14.7/ 373.4	13.8/ 350.5	N/A	N/A	7.2/ 182.9	195/ 88.5
RL-120002B14	1200	0.019	1270	17/ 431.8	14.9/ 378.5	16.2/ 411.5	N/A	N/A	7.2/ 182.9	275/ 124.7
RL-120003B14	1200	0.03	1530	17/ 431.8	14.7/ 373.4	17.7/ 449.6	N/A	N/A	7.2/ 182.9	390/ 176.9
RL-140001	1400	0.008	1235	21/ 533.4	16.6/ 421.6	15.2/ 386.1	N/A	N/A	N/A	500/ 226.8

For detailed drawings of each reactor, click on the “MTE Part Number”.

RL Line/Load Reactors Technical and Mechanical Specifications

Table 4-14: RL Reactors Open Panel Technical Specifications (continued)

MTE Part Number	Amps Rating	Inductance mh	Watts Loss	A	B	C	D	E	F	Approx Weight
				in./mm	in./mm	in./mm	in./mm	in./mm	in./mm	Lbs./Kg
RL-140002	1400	0.016	1523	21/ 533.4	16.6/ 421.6	17.1/ 434.3	N/A	N/A	N/A	525/ 238.1
RL-140003	1400	0.027	1680	21/ 533.4	16.8/ 426.7	22/ 558.8	N/A	N/A	N/A	850/ 385.6
RL-150001	1500	0.008	1432	18/ 457.2	16.8/ 426.7	15.4/ 391.2	N/A	N/A	N/A	635/ 288
RL-150002	1500	0.015	1100	18/ 457.2	16.8/ 426.7	15.5/ 393.7	N/A	N/A	N/A	460/ 208.7
RL-150003	1500	0.025	2621	21/ 533.4	16.6/ 421.6	19.9/ 505.5	N/A	N/A	N/A	760/ 344.7

For detailed drawings of each reactor, click on the “MTE Part Number”.

RL Line/Load Reactors Technical and Mechanical Specifications

Table 4-15: RL Reactors NEMA 1/2 Technical Specifications

Amps Rating	MTE Part Number	Cabinet Part Number	Cabinet Dimensions (H x W x D)		Approx. Weight		Inductance mH
			Inches	Millimeters	Lbs	Kgs	
1	RL-00111	CAB-8	8.0 x 8.2 x 6.3	203 x 208 x 160	9	4	100
	RL-00112				9	4	50
	RL-00113				8	4	36
	RL-00114				8	4	18
2	RL-00211	CAB-8	8.0 x 8.2 x 6.3	203 x 208 x 160	9	4	12
	RL-00212				9	4	20
	RL-00213				9	4	32
	RL-00214				8	4	6
4	RL-00411	CAB-8	8.0 x 8.2 x 6.3	203 x 208 x 160	9	4	3
	RL-00412				9	4	6.5
	RL-00413				10	5	9
	RL-00414				11	5	12
8	RL-00811	CAB-8	8.0 x 8.2 x 6.3	203 x 208 x 160	12	5	1.5
	RL-00812				13	6	3
	RL-00813				16	7	5
	RL-00814				18	8	7.5
12	RL-01211	CAB-8	8.0 x 8.2 x 6.3	203 x 208 x 160	14	6	1.25
	RL-01212				15	7	2.5
	RL-01213				23	10	4.2
18	RL-01811	CAB-8	8.0 x 8.2 x 6.3	203 x 208 x 160	14	6	0.8
	RL-01812				17	8	1.5
	RL-01813	CAB-13V	13.2 x 13.2 x 13.1	335 x 335 x 333	30	14	2.5
25	RL-02511	CAB-13V	13.2 x 13.2 x 13.1	335 x 335 x 333	25	11	0.5
	RL-02512				28	13	1.2
	RL-02513				34	15	1.8
35	RL-03511	CAB-13V	13.2 x 13.2 x 13.1	335 x 335 x 333	28	13	0.4
	RL-03512				30	14	0.8
	RL-03513				40	18	1.2
45	RL-04511	CAB-13V	13.2 x 13.2 x 13.1	335 x 335 x 333	36	16	0.3
	RL-04512				40	18	0.7
	RL-04513				48	22	1.2

For detailed drawings of each cabinet, click on the “Cabinet Part Number”.

RL Line/Load Reactors Technical and Mechanical Specifications

Table 4-15: RL Reactors NEMA 1/2 Technical Specifications (continued)

Amps Rating	MTE Part Number	Cabinet Part Number	Cabinet Dimensions (H x W x D)		Approx. Weight		Inductance mH
			Inches	Millimeters	Lbs	Kgs	
55	RL-05511	CAB-13V	13.2 x 13.2 x 13.1	335 x 335 x 333	38	17	0.25
	RL-05512				40	18	0.5
	RL-05513				48	22	0.85
80	RL-08011	CAB-13V	13.2 x 13.2 x 13.1	335 x 335 x 333	39	18	0.2
	RL-08012				47	21	0.4
	RL-08013				77	35	0.7
100	RL-10011	CAB-13V	13.2 x 13.2 x 13.1	335 x 335 x 333	43	20	0.15
	RL-10012				51	23	0.3
	RL-10013				81	37	0.45
130	RL-13011	CAB-13V	13.2 x 13.2 x 13.1	335 x 335 x 333	43	20	0.1
	RL-13012				57	26	0.2
	RL-13013				78	35	0.3
160	RL-16011	CAB-13V	13.2 x 13.2 x 13.1	335 x 335 x 333	55	25	0.075
	RL-16012				68	31	0.15
	RL-16013				88	40	0.23
200	RL-20011B14	CAB-13V	13.2 x 13.2 x 13.1	335 x 335 x 333	52	24	0.055
	RL-20012B14				68	31	0.11
	RL-20013B14				114	52	0.185
250	RL-25011B14	CAB-13V	13.2 x 13.2 x 13.1	335 x 335 x 333	61	28	0.045
	RL-25012B14	CAB-17V	24.0 x 17.1 x 18.5	610 x 434 x 470	123	56	0.09
	RL-25013B14				168	76	0.15
320	RL-32011B14	CAB-17V	24.0 x 17.1 x 18.5	610 x 434 x 470	123	56	0.04
	RL-32012B14				145	66	0.075
	RL-32013B14				203	92	0.125
400	RL-40011B14	CAB-17V	24.0 x 17.1 x 18.5	610 x 434 x 470	127	58	0.03
	RL-40012B14				161	73	0.06
	RL-40013B14				192	87	0.105
500	RL-50011B14	CAB-17V	24.0 x 17.1 x 18.5	610 x 434 x 470	136	62	0.025
	RL-50012	CAB-26C2	47.0 x 26.6 x 24.9	1194 x 676 x 632	297	135	0.05
	RL-50013				347	157	0.085

For detailed drawings of each cabinet, click on the “Cabinet Part Number”.

RL Line/Load Reactors Technical and Mechanical Specifications

Table 4-15: RL Reactors NEMA 1/2 Technical Specifications (continued)

Amps Rating	MTE Part Number	Cabinet Part Number	Cabinet Dimensions (H x W x D)		Approx. Weight		Inductance mH
			Inches	Millimeters	Lbs	Kgs	
600	RL-60011	CAB-26C2	47.0 x 26.6 x 24.9	1194 x 676 x 632	257	117	0.02
	RL-60012				312	142	0.04
	RL-60013				407	185	0.065
750	RL-75011	CAB-26C2	47.0 x 26.6 x 24.9	1194 x 676 x 632	277	126	0.015
	RL-75012				327	148	0.029
	RL-75013				402	182	0.048
850	RL-85011B14	CAB-26C2	47.0 x 26.6 x 24.9	1194 x 676 x 632	332	151	0.015
	RL-85012B14				352	160	0.027
	RL-85013B14	CAB-26D2	72.0 x 26.6 x 24.9	1829 x 676 x 632	481	218	0.042
900	RL-90011B14	CAB-26D2	72.0 x 26.6 x 24.9	1829 x 676 x 632	361	164	0.014
	RL-90012B14				381	173	0.025
	RL-90013B14				481	218	0.04
1000	RL-100011B14	CAB-26D2	72.0 x 26.6 x 24.9	1829 x 676 x 632	310	141	0.011
	RL-100012B14				381	173	0.022
	RL-100013B14				481	218	0.038
1200	RL-120011B14	CAB-26D2	72.0 x 26.6 x 24.9	1829 x 676 x 632	361	164	0.009
	RL-120012B14				441	200	0.019
	RL-120013B14				556	252	0.03
1400	RL-140011	CAB-42C2	72.0 x 42.6 x 30.9	1829 x 1082 x 785	815	370	0.008
	RL-140012				840	381	0.016
	RL-140013				1165	528	0.027
1500	RL-150011	CAB-42C2	72.0 x 42.6 x 30.9	1829 x 1082 x 785	950	431	0.008
	RL-150012				775	352	0.015
	RL-150013				1075	488	0.025

For detailed drawings of each cabinet, click on the “Cabinet Part Number”.

RL Line/Load Reactors Technical and Mechanical Specifications

Table 4-16: RL Reactors NEMA 3R Technical Specifications

Amps Rating	MTE Part Number	Cabinet Part Number	Cabinet Dimensions (H x W x D)		Approx. Weight		Inductance mH
			Inches	Millimeters	Lbs	Kgs	
1	RL-00131	CAB-12C3	24.0 x 12.5 x 17.9	610 x 318 x 455	61	28	100
	RL-00132				61	28	50
	RL-00133				60	27	36
	RL-00134				60	27	18
2	RL-00231	CAB-12C3	24.0 x 12.5 x 17.9	610 x 318 x 455	61	28	12
	RL-00232				61	28	20
	RL-00233				61	28	32
	RL-00234				60	27	6
4	RL-00431	CAB-12C3	24.0 x 12.5 x 17.9	610 x 318 x 455	61	28	3
	RL-00432				61	28	6.5
	RL-00433				62	28	9
	RL-00434				63	29	12
8	RL-00831	CAB-12C3	24.0 x 12.5 x 17.9	610 x 318 x 455	64	29	1.5
	RL-00832				65	29	3
	RL-00833				68	31	5
	RL-00834				70	32	7.5
12	RL-01231	CAB-12C3	24.0 x 12.5 x 17.9	610 x 318 x 455	66	30	1.25
	RL-01232				67	30	2.5
	RL-01233				75	34	4.2
18	RL-01831	CAB-12C3	24.0 x 12.5 x 17.9	610 x 318 x 455	66	30	0.8
	RL-01832				69	31	1.5
	RL-01833				73	33	2.5
25	RL-02531	CAB-17C3	31.0 x 17.6 x 26.0	787 x 447 x 660	99	45	0.5
	RL-02532				102	46	1.2
	RL-02533				108	49	1.8
35	RL-03531	CAB-17C3	31.0 x 17.6 x 26.0	787 x 447 x 660	102	46	0.4
	RL-03532				104	47	0.8
	RL-03533				114	52	1.2
45	RL-04531	CAB-17C3	31.0 x 17.6 x 26.0	787 x 447 x 660	110	50	0.3
	RL-04532				114	52	0.7
	RL-04533				122	55	1.2

For detailed drawings of each cabinet, click on the “Cabinet Part Number”.

RL Line/Load Reactors Technical and Mechanical Specifications

Table 4-16: RL Reactors NEMA 3R Technical Specifications (continued)

Amps Rating	MTE Part Number	Cabinet Part Number	Cabinet Dimensions (H x W x D)		Approx. Weight		Inductance mH
			Inches	Millimeters	Lbs	Kgs	
55	RL-05531	CAB-17C3	31.0 x 17.6 x 26.0	787 x 447 x 660	112	51	0.25
	RL-05532				114	52	0.5
	RL-05533				122	55	0.85
80	RL-08031	CAB-17C3	31.0 x 17.6 x 26.0	787 x 447 x 660	113	51	0.2
	RL-08032				121	55	0.4
	RL-08033				151	68	0.7
100	RL-10031	CAB-17C3	31.0 x 17.6 x 26.0	787 x 447 x 660	117	53	0.15
	RL-10032				125	57	0.3
	RL-10033				155	70	0.45
130	RL-13031	CAB-17C3	31.0 x 17.6 x 26.0	787 x 447 x 660	117	53	0.1
	RL-13032				131	59	0.2
	RL-13033				152	69	0.3
160	RL-16031	CAB-17C3	31.0 x 17.6 x 26.0	787 x 447 x 660	129	59	0.075
	RL-16032				142	64	0.15
	RL-16033				162	73	0.23
200	RL-20031B14	CAB-17C3	31.0 x 17.6 x 26.0	787 x 447 x 660	126	57	0.055
	RL-20032B14				142	64	0.11
	RL-20033B14				188	85	0.185
250	RL-25031B14	CAB-17C3	31.0 x 17.6 x 26.0	787 x 447 x 660	135	61	0.045
	RL-25032B14				168	76	0.09
	RL-25033B14				213	97	0.15
320	RL-32031B14	CAB-17C3	31.0 x 17.6 x 26.0	787 x 447 x 660	168	76	0.04
	RL-32032B14				190	86	0.075
	RL-32033B14				248	112	0.125
400	RL-40031B14	CAB-17C3	31.0 x 17.6 x 26.0	787 x 447 x 660	172	78	0.03
	RL-40032B14				206	93	0.06
	RL-40033B14				237	108	0.105
500	RL-50031B14	CAB-17C3	31.0 x 17.6 x 26.0	787 x 447 x 660	181	82	0.025
	RL-50032	CAB-26C3	47.0 x 26.6 x 30.0	1194 x 676 x 762	319	145	0.05
	RL-50033				369	167	0.085

For detailed drawings of each cabinet, click on the “Cabinet Part Number”.



RL Line/Load Reactors Technical and Mechanical Specifications

Table 4-16: RL Reactors NEMA 3R Technical Specifications (continued)

Amps Rating	MTE Part Number	Cabinet Part Number	Cabinet Dimensions (H x W x D)		Approx. Weight		Inductance mH
			Inches	Millimeters	Lbs	Kgs	
600	RL-60031	CAB-26C3	47.0 x 26.6 x 30.0	1194 x 676 x 762	279	127	0.02
	RL-60032				334	151	0.04
	RL-60033				429	195	0.065
750	RL-75031	CAB-26C3	47.0 x 26.6 x 30.0	1194 x 676 x 762	299	136	0.015
	RL-75032				349	158	0.029
	RL-75033				424	192	0.048
850	RL-85031B14	CAB-26C3	47.0 x 26.6 x 30.0	1194 x 676 x 762	354	161	0.015
	RL-85032B14				374	170	0.027
	RL-85033B14	CAB-26D3	72.0 x 26.6 x 34.0	1829 x 676 x 864	494	224	0.042
900	RL-90031B14	CAB-26D3	72.0 x 26.6 x 34.0	1829 x 676 x 864	374	170	0.014
	RL-90032B14				395	179	0.025
	RL-90033B14				494	224	0.04
1000	RL-100031B14	CAB-26D3	72.0 x 26.6 x 34.0	1829 x 676 x 864	323	147	0.011
	RL-100032B14				394	179	0.022
	RL-100033B14				494	224	0.038
1200	RL-120031B14	CAB-26D3	72.0 x 26.6 x 34.0	1829 x 676 x 864	374	170	0.009
	RL-120032B14				454	206	0.019
	RL-120033B14				569	258	0.03
1400	RL-140031	CAB-42C3	72.0 x 42.6 x 40.0	1829 x 1082 x 1016	859	390	0.008
	RL-140032				884	401	0.016
	RL-140033				1209	548	0.027
1500	RL-150031	CAB-42C3	72.0 x 42.6 x 40.0	1829 x 1082 x 1016	994	451	0.008
	RL-150032				819	371	0.015
	RL-150033				1119	508	0.025

For detailed drawings of each cabinet, click on the “Cabinet Part Number”.

5. HOW TO INSTALL Installation Checklist

 WARNING	<p>Prior to installation, please refer to all general warnings on pages 1 & 2. Failure to practice this can result in bodily injury!</p>
	<p>Input and output wiring to the reactor should be performed by authorized personnel in accordance with NEC and all local electrical codes and regulations.</p>
 WARNING	<p>The reactor is designed for use with copper conductors with a minimum temperature rating of 75 degrees C.</p>
	<p>MTE NEMA 1 enclosures designed for floor mounting must be mounted with the enclosure base horizontal for proper ventilation. Wall mounting a floor mounted enclosure with the base against the wall will cause the reactor to overheat resulting in equipment damage.</p>

RL Line/Load Reactors are supplied in the following configurations:

- Open Reactors: These reactors are designed for mounting within an appropriate electrical equipment enclosure.
- NEMA 1/2 & 3R general purpose cabinets: Reactors are supplied in a wall mounted or floor mounted cabinet.

Open Reactors Installation Guidelines:

Reactors rated 300 amperes RMS and under are designed for mounting in both a vertical and horizontal position. Larger reactors must be mounted in a horizontal position typically on the floor of the enclosure. Include the power dissipation of the reactor along with all the other components located in the enclosure to determine the internal temperature rise and cooling requirements of the enclosure. Reactors may be located in any region of the enclosure where the ambient temperature does not exceed 45 degrees C. A general guideline is to allow a **side clearance** of **four (4)** inches and a **vertical clearance** of **six (6)** inches for proper heat dissipation and access within the enclosure. Clearances may be less if proper ventilation exists. Reactors must operate within temperatures specified in this manual or operating life will be compromised. Also, be aware of minimum electrical clearances as defined by the appropriate system safety standard(s).

NEMA 1/2 & 3R Installation Guidelines:

MTE line/load reactors mounted in CAB-8 and CAB-13V enclosures are designed for wall mounting. All other enclosures are designed for floor mounting. Allow a minimum **side, front, and back clearances** of **twelve (12)** inches and **vertical clearances** of **eighteen (18)** inches for proper heat dissipation and access.

General Installation Guidelines:

Select a well ventilated, dust-free area away from direct sunlight, rain or moisture. Do not install in or near a corrosive environment. Avoid locations where the reactor will be subjected to excessive vibrations. Do not locate the reactor next to resistors or any other component with operating surface temperatures above 125 degree C.

Grounding

 WARNING	The reactor must always be grounded with a grounding conductor connected to ground terminals.
	For open reactors, ensure a 2” x 2” area is cleaned of paint and varnish on lower mounting bracket for ground connection.

NOTE: For cable shield grounding follow the drive manufacturer’s recommendations.

Grounding and Ground Fault Protection

Due to high leakage currents associated with variable frequency drives, ground fault protective devices do not necessarily operate correctly when placed ahead of a RL Line/Load Reactor feeding a drive. When using this type of device, its function should be tested in the actual installation.

Open reactors must be grounded at the designated grounding terminal or the reactor mounting holes if no designated grounding terminal is provided.

A stud is provided on enclosed reactors for grounding the enclosure. The enclosure must be grounded.

Power Wiring Connection

 WARNING	<p>Input and output power wiring to the reactor should be performed by authorized personnel in accordance with the NEC and all local electrical codes and regulations. Cable lugs and mounting hardware are provided by the customer.</p>
	<p>Any extremely low or high resistance readings indicate a mis-wire and may result in damage to reactor if not corrected.</p>

Verify that the power source to which the reactor is to be connected is in agreement with the nameplate data on the reactor. A fused disconnect switch or circuit breaker should be installed between the reactor and its source of power in accordance with the requirements of the NEC and all local electrical codes and regulations. Refer to the drive user manual for selection of the correct fuse rating and class.

The reactor is suitable for use on a circuit capable of delivering not more than 65,000 rms symmetrical amperes at 480 volts when protected by Bussman type JJS, KTK, KTK-R, SPP or T class fuses.

Reactor are designed for use with copper conductors with a minimum temperature rating of 75 degrees C. Table 5-1: RL Reactors Torque Ratings (p40) lists the wire range and terminal torque requirements for the power input and output connections by reactor part number.

Refer to Figures 5-1 – 5-4 on page 39 for typical electrical diagrams describing the application of reactors in both line and load applications. For reactors supplied as a component part of a drive system or a component part of power electronic apparatus follow the interconnection diagram supplied by the System Engineer.

Where desirable, a flexible conduit connection to the reactor enclosure should be made to reduce audible noise.

Typical Connection Diagrams

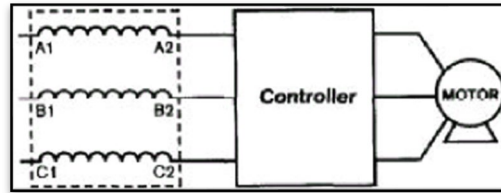

Figure 5-1: Line Reactor

Connects between power source and VFD

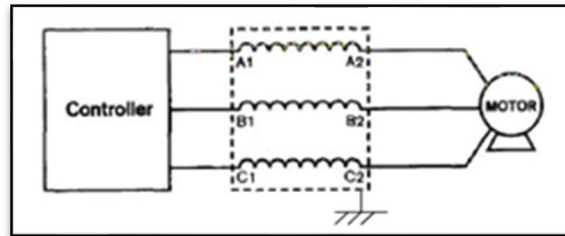

Figure 5-2: Load Reactor

Connects between VFD and load (motor)

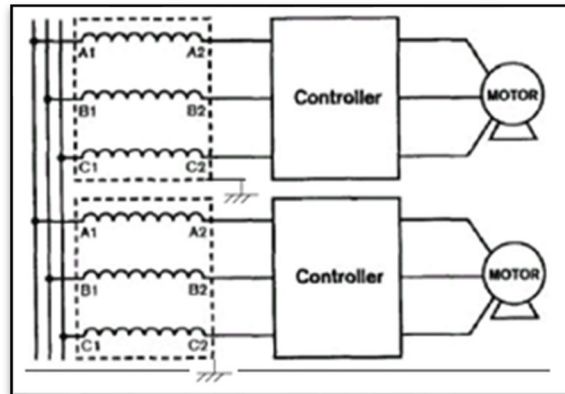

Figure 5-3: Multiple Line Reactors

Use individual line reactors for independent start/stop drives connected to a common power source. If inverters are slaved and will always run together, a single reactor sized for total motor current may be used.

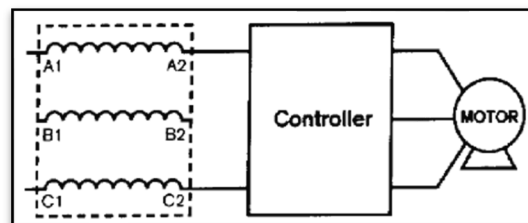

Figure 5-4: Single Phase Line Reactors

Standard three phase reactors may be used for single phase applications. Visit the [MTE website](http://www.mte.com) for more information.

Torque Ratings

Table 5-1: RL Reactors Torque Ratings

Amps Rating	Max Amps	MTE Part Number	Wire Range (AWG)	Terminal Torque (in-lbs.)
1	1.5	RL-00101	22 – 10	4.5
		RL-00102	22 – 10	4.5
		RL-00103	22 – 10	4.5
		RL-00104	22 – 10	4.5
2	3	RL-00201	22 – 10	4.5
		RL-00202	22 – 10	4.5
		RL-00203	22 – 10	4.5
		RL-00204	22 – 10	4.5
4	6	RL-00401	22 – 10	4.5
		RL-00402	22 – 10	4.5
		RL-00403	22 – 10	4.5
		RL-00404	22 – 10	4.5
8	12	RL-00801	22 – 10	4.5
		RL-00802	22 – 10	4.5
		RL-00803	22 – 10	4.5
		RL-00804	22 – 10	4.5
12	18	RL-01201	14 – 6	16
		RL-01202	14 – 6	16
		RL-01203	14 – 6	16
18	27	RL-01801	14 – 6	16
		RL-01802	14 – 6	16
		RL-01803	14 – 6	16
25	37.5	RL-02501	14 – 6	16
		RL-02502	14 – 6	16
		RL-02503	14 – 6	16
35	52.5	RL-03501	14 – 6	16
		RL-03502	14 – 6	16
		RL-03503	18 – 4	16
45	67.5	RL-04501	18 – 4	16
		RL-04502	18 – 4	16
		RL-04503	18 – 4	16

Torque Ratings

Table 5-1: RL Reactors Torque Ratings (continued)

Amps Rating	Max Amps	MTE Part Number	Wire Range (AWG)	Terminal Torque (in-lbs.)
55	82.5	RL-05501	6 – 0	6 – 4 (45) & 2 – 0 (50)
		RL-05502	6 – 0	6 – 4 (45) & 2 – 0 (50)
		RL-05503	6 – 0	6 – 4 (45) & 2 – 0 (50)
80	120	RL-08001	6 – 0	6 – 4 (45) & 2 – 0 (50)
		RL-08002	6 – 0	6 – 4 (45) & 2 – 0 (50)
		RL-08003	6 – 0	6 – 4 (45) & 2 – 0 (50)
100	150	RL-10001	6 – 0	6 – 4 (45) & 2 – 0 (50)
		RL-10002	6 – 0	6 – 4 (45) & 2 – 0 (50)
		RL-10003	6 – 0	6 – 4 (45) & 2 – 0 (50)
130	195	RL-13001	2 – 0000	150
		RL-13002	2 – 0000	150
		RL-13003	2 – 0000	150
160	240	RL-16001	2 – 0000	150
		RL-16002	Copper Tab	Not Applicable
		RL-16003	Copper Tab	Not Applicable
200	300	RL-20001B14	Copper Tab	Not Applicable
		RL-20002B14	Copper Tab	Not Applicable
		RL-20003B14	Copper Tab	Not Applicable
250	375	RL-25001B14	Copper Tab	Not Applicable
		RL-25002B14	Copper Tab	Not Applicable
		RL-25003B14	Copper Tab	Not Applicable
320	480	RL-32001B14	Copper Tab	Not Applicable
		RL-32002B14	Copper Tab	Not Applicable
		RL-32003B14	Copper Tab	Not Applicable
400	600	RL-40001B14	Copper Tab	Not Applicable
		RL-40002B14	Copper Tab	Not Applicable
		RL-40003B14	Copper Tab	Not Applicable
500	750	RL-50001B14	Copper Tab	Not Applicable
		RL-50002	Copper Tab	Not Applicable
		RL-50003	Copper Tab	Not Applicable

Torque Ratings

Table 5-1: RL Reactors Torque Ratings (continued)

Amps Rating	Max Amps	MTE Part Number	Wire Range (AWG)	Terminal Torque (in-lbs.)
600	900	RL-60001	Copper Tab	Not Applicable
		RL-60002	Copper Tab	Not Applicable
		RL-60003	Copper Tab	Not Applicable
750	1050	RL-75001	Copper Tab	Not Applicable
		RL-75002	Copper Tab	Not Applicable
		RL-75003	Copper Tab	Not Applicable
850	1275	RL-85001B14	Copper Tab	Not Applicable
		RL-85002B14	Copper Tab	Not Applicable
		RL-85003B14	Copper Tab	Not Applicable
900	1350	RL-90001B14	Copper Tab	Not Applicable
		RL-90002B14	Copper Tab	Not Applicable
		RL-90003B14	Copper Tab	Not Applicable
1000	1500	RL-100001B14	Copper Tab	Not Applicable
		RL-100002B14	Copper Tab	Not Applicable
		RL-100003B14	Copper Tab	Not Applicable
1200	1800	RL-120001B14	Copper Tab	Not Applicable
		RL-120002B14	Copper Tab	Not Applicable
		RL-120003B14	Copper Tab	Not Applicable
1400	2100	RL-140001	Copper Tab	Not Applicable
		RL-140002	Copper Tab	Not Applicable
		RL-140003	Copper Tab	Not Applicable
1500	2250	RL-150001	Copper Tab	Not Applicable
		RL-150002	Copper Tab	Not Applicable
		RL-150003	Copper Tab	Not Applicable

6. START-UP

Safety Precautions

Before start-up, observe the following warnings and instructions:

 WARNING	<p>Use extreme caution to avoid contact with line voltage when checking for power. INJURY OR DEATH MAY RESULT IF SAFETY PRECAUTIONS ARE NOT OBSERVED.</p>
	<p>High voltage is used in the operation of line/load reactors. Use EXTREME caution to avoid contact with high voltage when operating, installing, or repairing equipment containing line/load reactors. Line/load reactors are used in conjunction with inverters, or other electrical equipment that may feedback lethal voltages.</p>
	<p>Internal components of the reactor are at line potential when the reactor is connected to the drive. This voltage is extremely dangerous and may cause death or severe injury if you come in contact with it.</p>
	<p>Reactors are a component part of an electrical system. Do not proceed with startup until the system startup instructions provided by the System Engineer are understood and followed. Injury, death and damage to equipment may result if the system startup instructions are not followed.</p>

Sequence of Operation

1. Read and follow safety precautions.
2. After installation, ensure that:
 - All reactor ground terminals are connected to ground.
 - Power wiring to the utility, drive and motor is in accordance with the power wiring connection diagrams shown in installation instructions section.
 - Use the guidelines of Table 5-1: RL Reactors Torque Ratings (p40) for power wire gauges.
3. Check that moisture has not condensed on the reactor. If moisture is present, do not proceed with start-up until the moisture has been removed.
4. Refer to the drive user manual for the drive start-up procedure. Observe all safety instructions in the drive user manual.

7. TROUBLESHOOTING

 WARNING	<p>When properly installed, this equipment has been designed to provide maximum safety for operating personnel. However, hazardous voltages and elevated temperatures exist within the confines of the enclosure. Servicing should therefore be performed by qualified personnel only and in accordance with OSHA Regulations.</p>
	<p>High voltage is used in the operation of this reactor. Use Extreme caution to avoid contact with high voltage when operating, installing or repairing this filter. INJURY OR DEATH MAY RESULT IF SAFETY PRECAUTIONS ARE NOT OBSERVED.</p>

To aid in troubleshooting, four typical connection diagrams and a troubleshooting guide that lists potential problems and solutions are included:

Figure 5-1: Line Reactor (p39)

Figure 5-2: Load Reactor (p39)

Figure 5-3: Multiple Line Reactors (p39)

Figure 5-4: Single Phase Line Reactors (p39)

Table 7-1: Troubleshooting Guide (p45)

Table 7-1: Troubleshooting Guide

PROBLEM: Line voltage is not present at the reactor output terminals.	
Possible cause:	Power to the reactor is turned off.
Solution:	Turn power on.
Possible cause:	One or more external line fuses are blown.
Solution:	Verify the continuity of line fuses in all phases. Replace as necessary.
PROBLEM: Filter output voltage is not within specification	
Possible cause:	Reactor input voltage is not within specification.
Solution:	Check the AC input line voltage and verify that it is within tolerance. Refer to the reactor service conditions and performance specifications for tolerances.
Possible cause:	Source impedance is out of tolerance.
Solution:	Verify that the source impedance is within tolerance. Refer to the reactor service conditions and performance specifications for tolerances.
Possible cause:	Drive set up parameter does not allow for input reactor.
Solution:	Consult drive manufacturer to update setup to accommodate input reactor.
Possible cause:	Input voltage subject to extreme transients such as switching between two voltage sources. Drive faults on over or under voltage.
Solution:	Source switching is not recommended without proper phase synchronizing or allowing reasonable time delay before transfer to new source.

RL Reactor Technical Reference Manual			RL-TRM-E
Responsibility: VP Business Development and Product Management Approved By: Z Zakaria ISO Section: 7.2.3			
Revision	Date	Revision History	Changed By
001	04/25/19	New document written	Marc Majewski
002	06/18/19	Updated cabinet number for RL-85013B14	Marc Majewski