

APPROX WEIGHT (LBS)
19

ECO No	DESCRIPTION	REV BY	DATE
M10014	ADDED REAR MOUNTING BRACKET TO REACTOR	MN	11/29/16

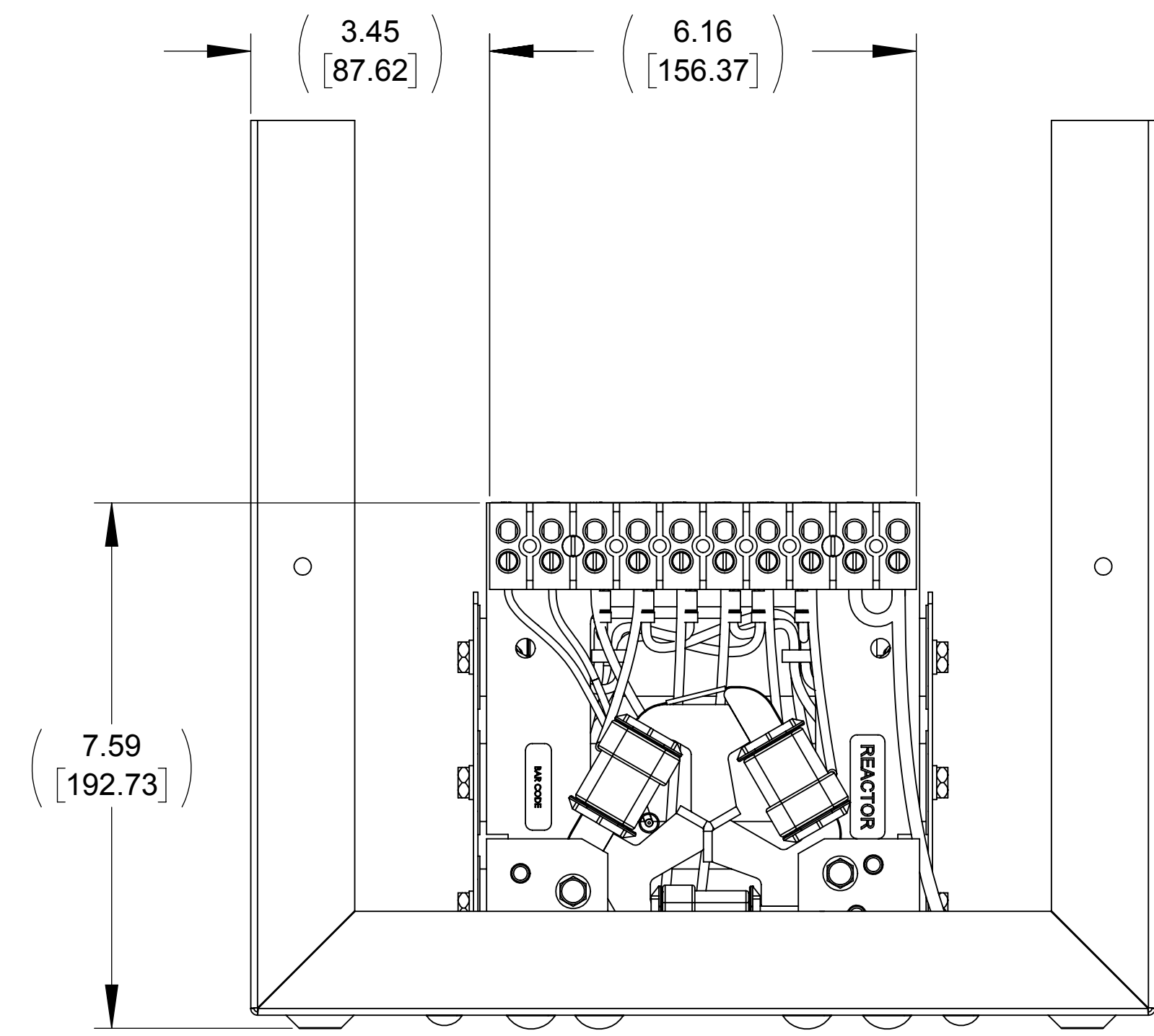

**FRONT VIEW
(PANEL REMOVED)**

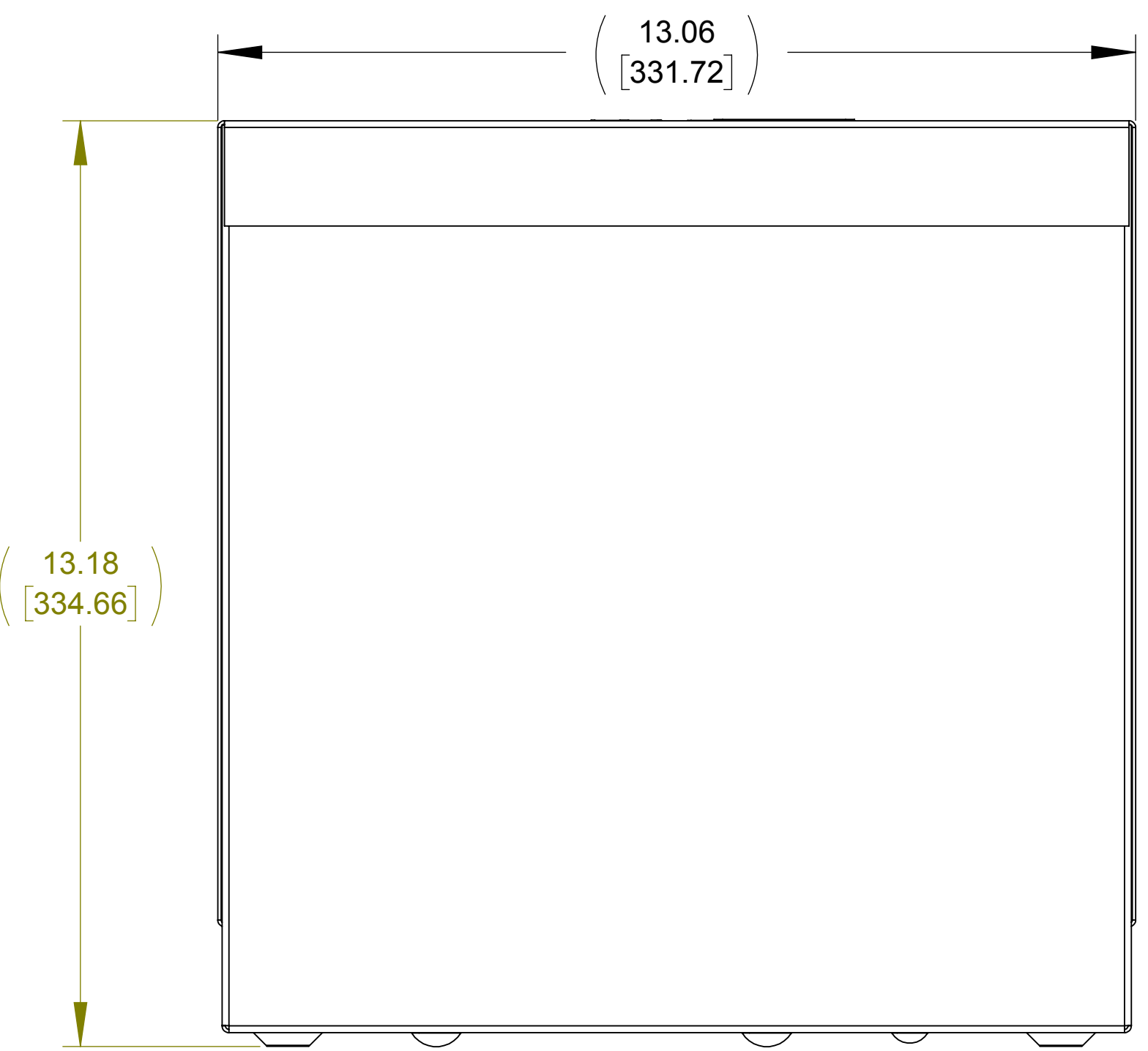

SIDE VIEW

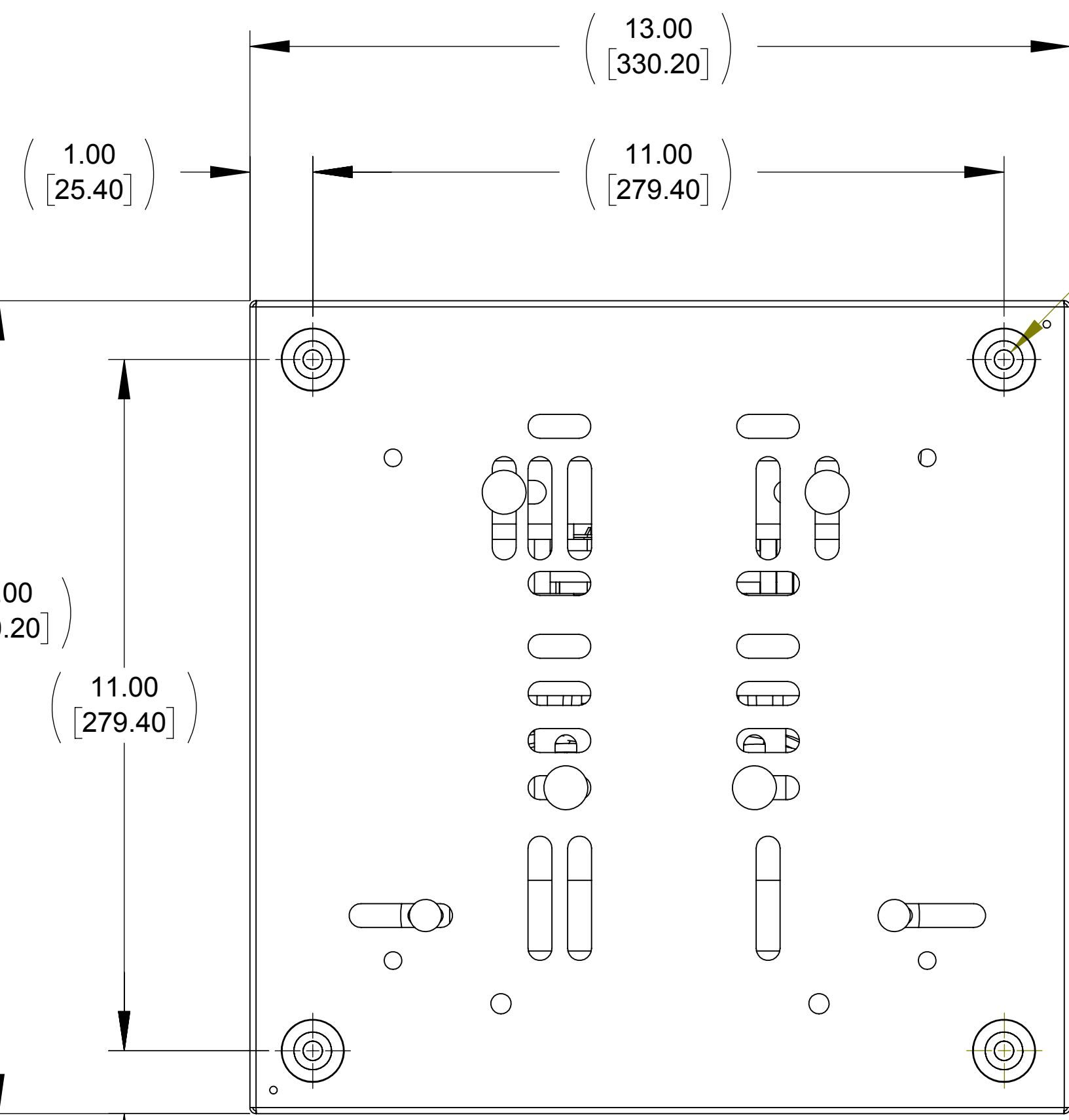
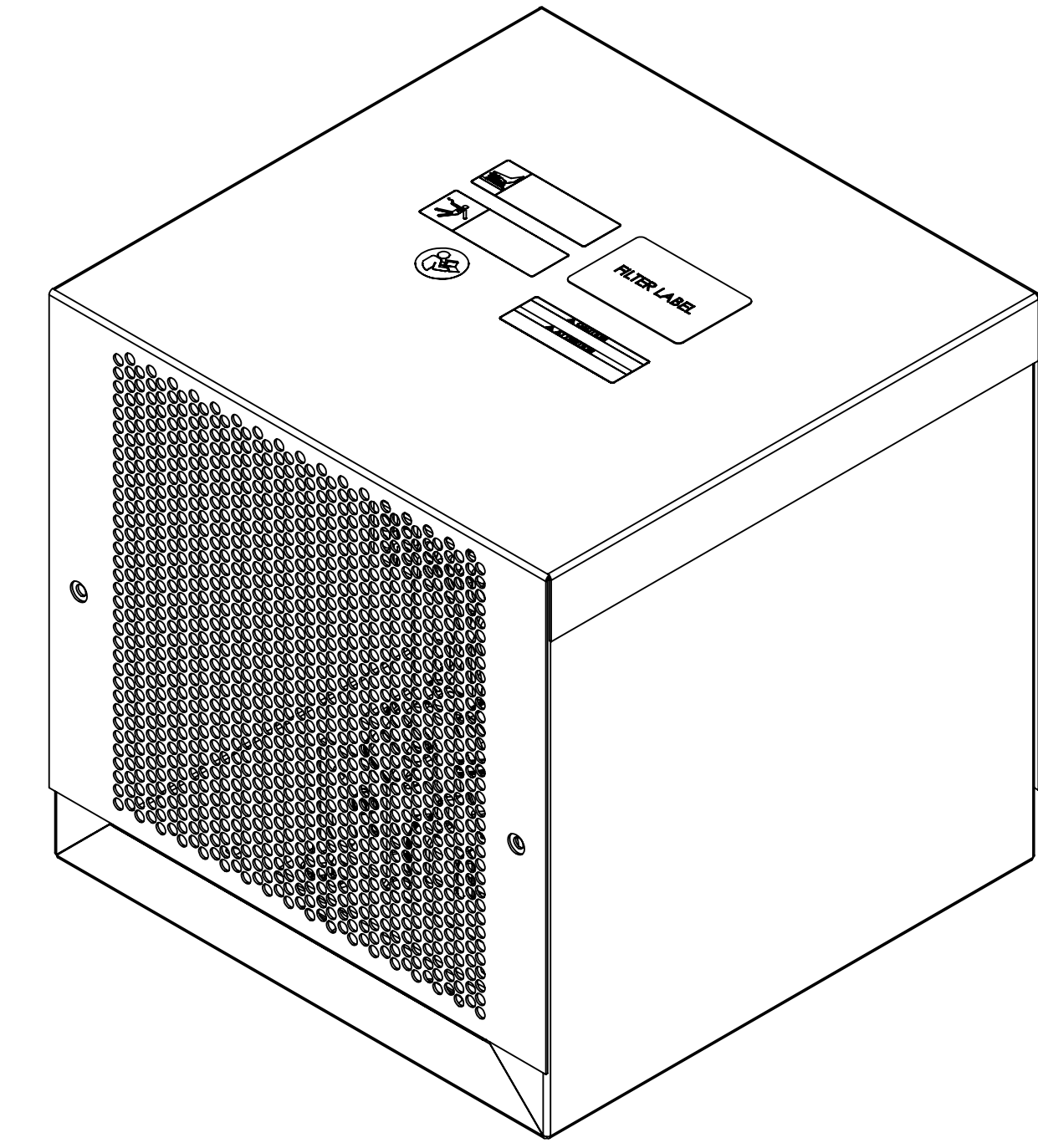

BOTTOM VIEW

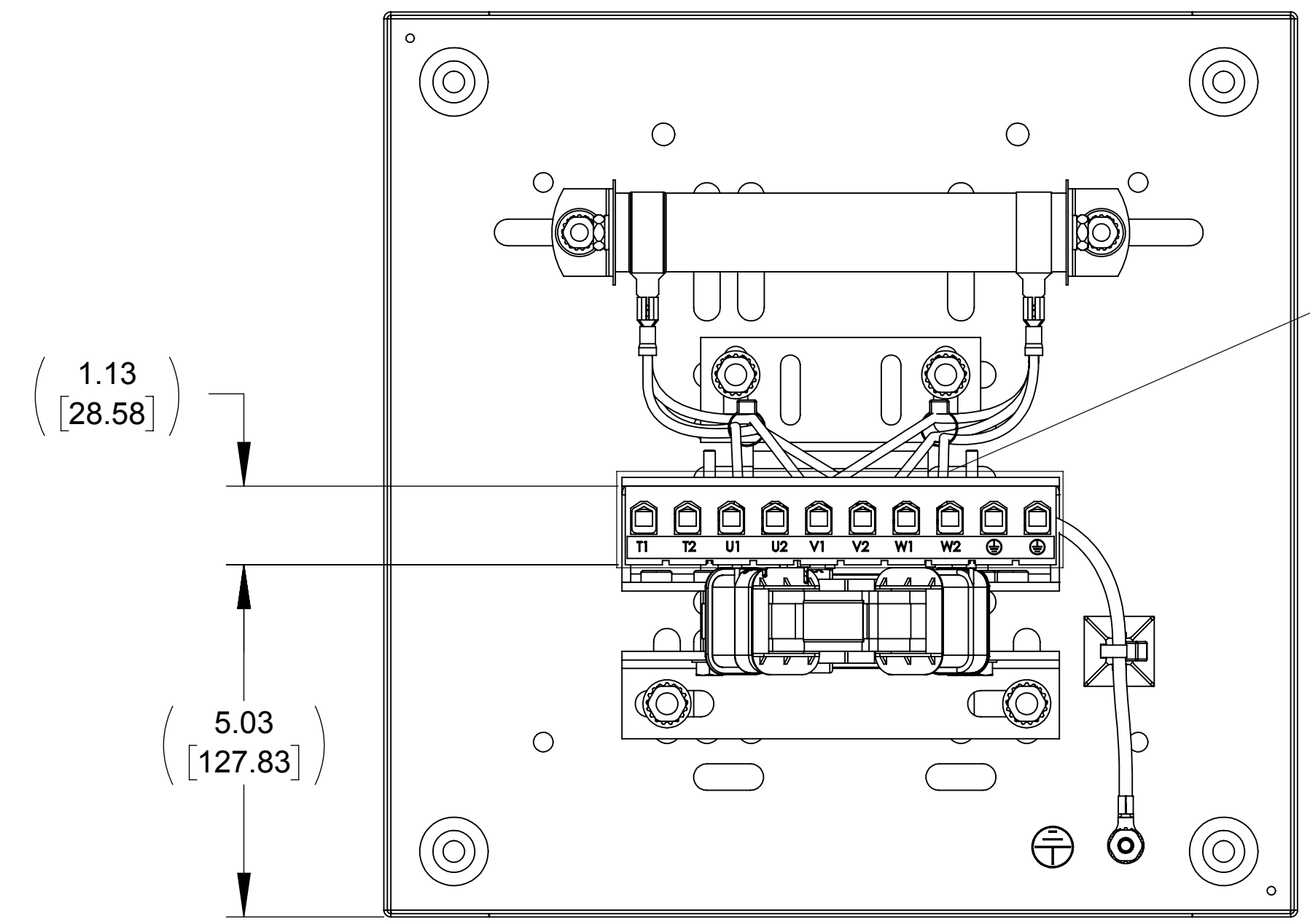

**TOP VIEW
(PANEL REMOVED)**

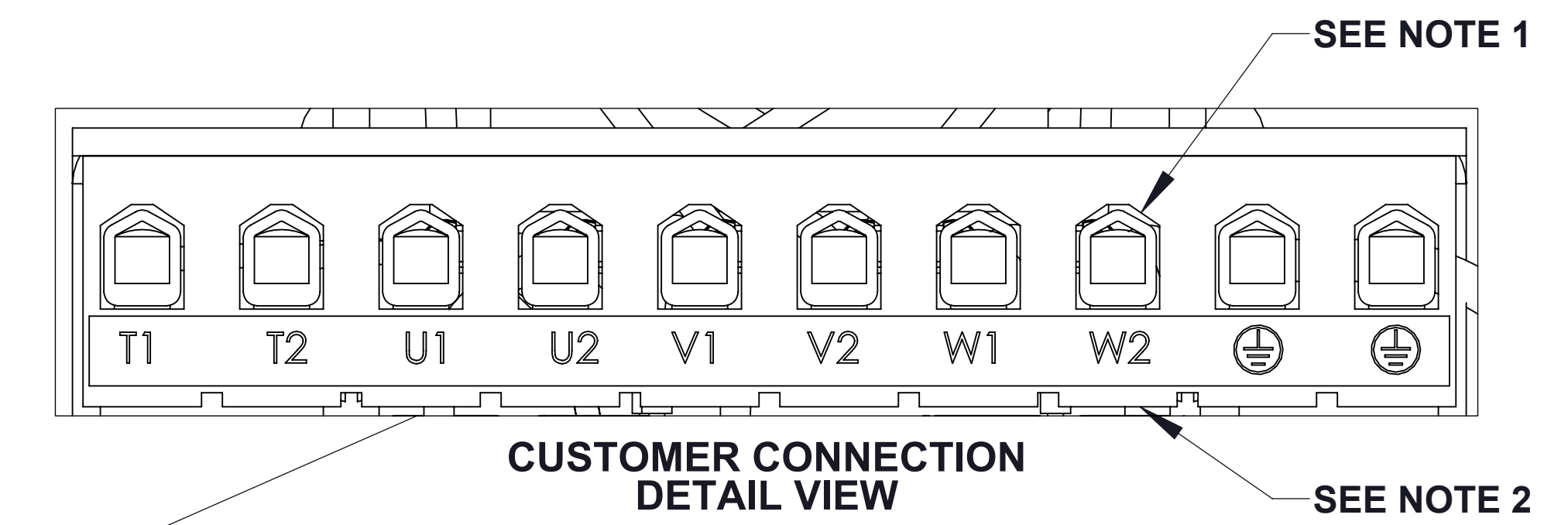

**CUSTOMER CONNECTION
DETAIL VIEW**

NOTES:

1. WIRE RANGE: 4 - 18 AWG.
2. TERMINAL SCREW TIGHTENING TORQUE: 16 IN/LBS.

<p>THE COMPONENT, PART OR ASSEMBLY DESCRIBED IN THIS DOCUMENT MUST COMPLY WITH THE EU (EUROPEAN UNION) DIRECTIVE RoHS2</p> <p>CONTAINS <0.1% OF ANY SVHC BY WEIGHT PER REACH REGULATION</p>		<p>MATERIAL</p>		<p>CONFIDENTIAL AND PROPRIETARY INFORMATION THIS DOCUMENT CONTAINS CONFIDENTIAL AND PROPRIETARY INFORMATION OF MTE CORPORATION AND MAY NOT BE USED, COPIED OR DISCLOSED TO OTHERS EXCEPT WITH THE AUTHORIZED WRITTEN PERMISSION OF MTE CORPORATION</p>	
<p>UNLESS OTHERWISE SPECIFIED DIMENSIONS ARE IN INCHES [MM] TOLERANCES ARE:</p> <p>ANGLES: ± 1°</p> <p>1 PLACE .X: ± .1 [2.5]</p> <p>2 PLACE .XX: ± .03 [0.76]</p> <p>3 PLACE .XXX: ± .010 [0.254]</p>		<p>N83 W13330 Leon Road Menomonee Falls, WI 53051 USA 800.455.4683 262.253.8200</p>		<p>DESCRIPTION</p> <p>DV SENTRY 7A 380-600V FILTER, NEMA 1/2 ENCL.</p>	
<p>DRAWN MM</p> <p>CHECKED TM</p> <p>APPROVED TM</p>		<p>DATE 07/21/14</p> <p>DATE 01/18/17</p> <p>DATE 01/18/17</p>		<p>SIZE D</p> <p>DWG No. CD DVSG0007E</p> <p>REV 03</p>	
<p>SCALE 1:2</p>		<p>SHEET 1 OF 1</p>			