

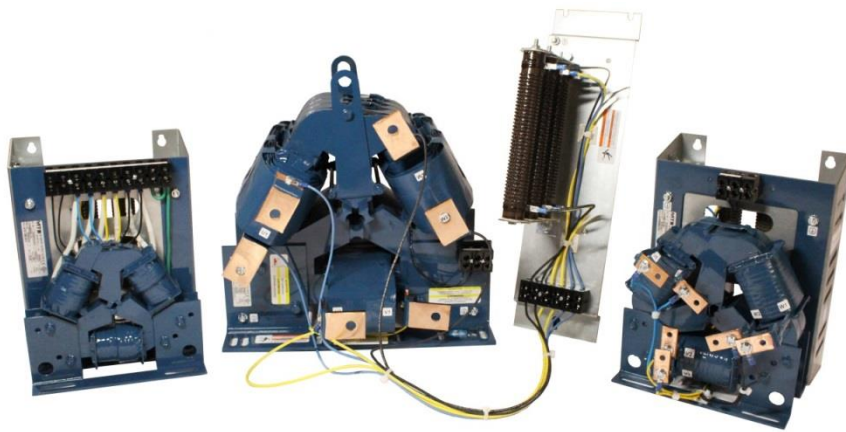

# dV Sentry™

## 208V – 600V

### TECHNICAL REFERENCE MANUAL



High Voltage! Only a qualified electrician can carry out the electrical installation of this filter.

#### Quick Reference

Quick Reference		
<b>1</b>	Performance Data	Pages 5 – 8
<b>2</b>	Selection Guide	Pages 9 – 13
<b>3</b>	Installation Guide	Pages 14 – 20
<b>4</b>	Start-up/Troubleshooting	Pages 21 – 23

**This page intentionally left blank**

## TABLE OF CONTENTS

<b>1. SAFETY</b> .....	<b>1</b>
WARNINGS AND CAUTIONS .....	1
PRODUCT SAFETY LABELING .....	1
GENERAL SAFETY INSTRUCTIONS .....	2
<b>2. GENERAL INFORMATION</b> .....	<b>3</b>
RECEIPT & REPAIR STATEMENT .....	3
ENCLOSURES .....	4
AGENCY APPROVALS .....	4
WARRANTY .....	4
<b>3. DV SENTRY PERFORMANCE DATA</b> .....	<b>5</b>
PERFORMANCE SPECIFICATIONS .....	5
FILTER EFFICIENCY + WATT LOSS .....	6
PERFORMANCE CHART .....	7
ALTITUDE DERATING .....	8
MOTOR FREQUENCY DERATING .....	8
<b>4. HOW TO SELECT</b> .....	<b>9</b>
SELECTION GUIDE .....	9
UNDERSTANDING THE DV SENTRY PART NUMBER: .....	10
PART NUMBER SELECTION TABLES .....	11
<b>5. HOW TO INSTALL</b> .....	<b>14</b>
INSTALLATION CHECKLIST .....	14
GROUNDING .....	15
POWER WIRING CONNECTION .....	16
BASIC SCHEMATIC DIAGRAM .....	17
INTERCONNECTION DIAGRAM – PANEL (3A-110A) AND ENCLOSED (3A-600A) .....	18
INTERCONNECTION DIAGRAM – MODULAR (130A-600A) .....	19
TORQUE RATINGS .....	20
<b>6. START-UP</b> .....	<b>21</b>
SAFETY PRECAUTIONS .....	21
<b>7. TROUBLESHOOTING</b> .....	<b>22</b>

## List of Figures

Figure 3-1: Typical Performance Chart .....	7
Figure 3-2: Altitude Derating Curve .....	8
Figure 3-3: Current Derating for Drive Output Frequency .....	8
Figure 5-1: Basic Schematic Diagram .....	17
Figure 5-2: Open Panel and Enclosed Diagram .....	18
Figure 5-3: Modular Diagram .....	19



## List of Tables

Table 3-1: Performance Specifications .....	5
Table 3-2: Filter Efficiency & Watt Loss .....	6
Table 4-1: Panel Selection Table .....	11
Table 4-2: Enclosed NEMA 1/2 Selection Table .....	12
Table 4-3: Enclosed NEMA 3R Selection Table .....	13
Table 5-1: Overtemperature Switch .....	15
Table 5-2: Torque Ratings .....	20
Table 7-1: Troubleshooting Guide .....	23

# 1. SAFETY



## Warnings and Cautions

The following symbols are used in this manual:



 <b>WARNING</b>	<p>High Voltage Warning: warns of situations that dangerously high voltage is involved. Failure to use proper precautions may lead to serious injury or death.</p>
 <b>WARNING</b>	<p>General Warning: warns of situations that can result in serious injury or death if proper precautions are not used.</p>
 <b>Caution</b>	<p>General Caution: identifies situations that could lead to malfunction or possible equipment damage.</p>

## Product Safety Labeling

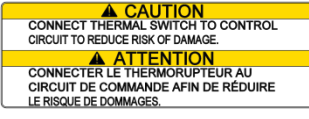
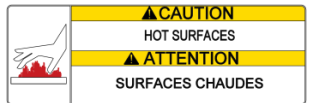
The following labels are placed on the dV Sentry product:

	<p>Label notes to install to refer to instruction manual first before installing.</p>
	<p>High Voltage: surfaces on product can have high voltage which can cause injury.</p>
	<p>Connect Thermal Switch: connecting the thermal switch can reduce risk of damage.</p>
	<p>Hot Surfaces: surfaces of product can be hot at times and cause burns.</p>

## General Safety Instructions

 <b>WARNING</b>	<p><b>High Voltage! Only a qualified electrician can carry out the electrical installation of this filter.</b></p>
	<p>High voltage is used in the operation of this filter. Use Extreme caution to avoid contact with high voltage when operating, installing or repairing this filter. <b>Injury or death may result if safety precautions are not observed.</b></p>
 <b>WARNING</b>	<p>The opening of the branch circuit protective device may be an indication that a fault current has been interrupted. To reduce the risk of fire or electrical shock, current-carrying parts and other components of the filter should be examined and replaced if damaged.</p>
	<p>An upstream disconnect/protection device must be used as required by the National Electrical Code (NEC) or governing authority.</p>
	<p>Even if the upstream disconnect/protection device is open, the drive down stream of the filter may feedback high voltage to the filter. The drive safety instructions must be followed. <b>Injury or death may result if safety precautions are not observed.</b></p>
	<p>The filter must be grounded with a grounding conductor connected to all grounding terminals. Modular filters must have reactor grounded through a 2"x2" area cleaned of paint and varnish on lower mounting bracket.</p>
	<p>Only spare parts obtained from MTE Corporation or an authorized MTE distributor can be used.</p>
 <b>Caution</b>	<p>Loose or improperly secured connections may damage or degrade filter performance. Visually inspect and secure all electrical connections before power is applied to the filter.</p>
	<p>Wiring should not be routed underneath panel in resistor housing. Doing so could result in fire or damage to the product.</p>
	<p>Product should not be mounted on wood or any other combustible surface. Doing so could lead to fire or damage to the product.</p>

## 2. GENERAL INFORMATION

The purpose of the manual is to properly specify size, install, interconnect and operate the dV Sentry motor protection filter.

For most current information, please refer to website  
<http://www.mtecorp.com/products/dv-sentry-dvdt-filters/>

This manual is intended for use by personnel experienced in the operation and maintenance of inverters. Because of the high voltages required by the filter, inverter and the potential dangers presented by rotating machinery, it is essential that all personnel involved in the operation and maintenance of this filter know and practice the necessary safety precautions for this type of equipment. Personnel should read and understand the instructions contained in this manual before installing, operating or servicing the filter and inverter to which it is connected.

### Receipt & Repair Statement

#### Upon Receipt of this Filter:

The dV Sentry motor protection filter has been subjected to demanding factory tests before shipment. Carefully inspect the shipping container for damage that may have occurred in transit. Then unpack the filter and carefully inspect for any signs of damage. Save the shipping container for future transport of the filter.

**In the event of damage, please contact and file a claim with the freight carrier involved immediately.**

If the equipment is not going to be put into service upon receipt, cover and store the filter in a clean, dry location. After storage, ensure that the equipment is dry and that no condensation or dirt has accumulated on the internal components of the filter before applying power.

#### Repair/Exchange Procedure:

MTE Corporation requires a Return Material Authorization Number and form before we can accept any filters that qualify for return or repair. If problems or questions arise during installation, setup, or operation of the filter, please contact MTE for assistance at:

Toll Free: 1-800-455-4MTE (1-800-455-4683)

International Tel: (+1) 262-253-8200

Fax: 262-253-8222

## Enclosures

MTE enclosures are designed to provide a degree of protection for electrical components and prevent incidental personnel contact with the enclosed equipment. Depending on the enclosure selected, these enclosures meet the requirements of NEMA 1/2 or 3R.

An approximate cross reference guide between NEMA, UL, CSA and IEC enclosure follows.

**Type 1 NEMA / IEC IP20 Enclosure:**

Are designed for indoor use and will provide protection against contact with the enclosed equipment.

**Type 2 NEMA / IEC IP20 Enclosure:**

Are designed for indoor use and will provide protection against contact with the enclosed equipment and provide a degree of protection against limited amounts of falling water and dirt.

**Type 3R NEMA / IEC IP23 Enclosure:**

Are designed for outdoor use primarily to provide protection against contact with the enclosed equipment and provide a degree of protection against falling rain sleet and external ice formation.

## Agency Approvals

UL and cUL listed to UL508 Type MX and CSA-C22.2 No 14-95  
File E180243

CE Marked

## Warranty

Three years from the date of shipment. See <http://www.mtecorp.com/industry-leading-warranty/> for details.



### 3. dV SENTRY PERFORMANCE DATA

#### Performance Specifications

**Table 3-1: Performance Specifications**

Service Load Condition	Inverter Duty Three Phase Motors
Voltage	208 – 600 VAC +/- 10%, 60Hz
Input Voltage Wave Form	PWM
Inverter Switching Frequency	2kHz – 10kHz (3-110A models) 2kHz – 5kHz (130A-600A models)
Inverter Operating Frequency	0 – 90 Hz without derating
Maximum Ambient Temperature	60C Open filters 50C Enclosed Filter
Insulation System	Class N (200° C)
Insertion Loss (Voltage)	1.7% at 60 Hz; 2.6% at 90 Hz
Efficiency	>99%
Current range	3A – 600A
Available form factors	Panel NEMA 1/2 NEMA 3R
Altitude without derating	3,300 feet above sea level
Maximum Motor Lead Length	1,000 feet (VFD rated cable recommended)
Relative Humidity	0% to 99% non-condensing
Current Rating	100% RMS Continuous 150% for 1 minute 200% for 10 sec *Operating in overload will result in increased proportional voltage drop
Audible Noise	<65db at 1 meter
Rise Time	Less than 0.1 uS
Peak Voltage @ Motor	150% of DC bus voltage up to 1,000 feet
Common Mode Reduction	50%+ Peak Current Reduction Typical

## Filter Efficiency + Watt loss

Table 3-2: Filter Efficiency & Watt Loss

Maximum Output Amps RMS/Filter Current Rating Amps RMS	Efficiency (%)	Typical Power Dissipation (Watts*)
3	99.3%	67
4	99.3%	67
7	99.3%	67
9	99.3%	67
12	99.3%	67
17	99.3%	96
22	99.5%	91
27	99.6%	92
35	99.7%	91
45	99.8%	88
55	99.7%	137
65	99.7%	166
80	99.8%	158
110	99.8%	175
130	99.7%	273
160	99.8%	289
200	99.8%	325
250	99.8%	423
305	99.8%	481
365	99.8%	564
415	99.8%	795
515	99.8%	795
600	99.8%	822

\*Based on a typical 480V, 60Hz output frequency, 1,000 feet of drive cable, 2kHz carrier frequency at full load application.

**Performance Chart**

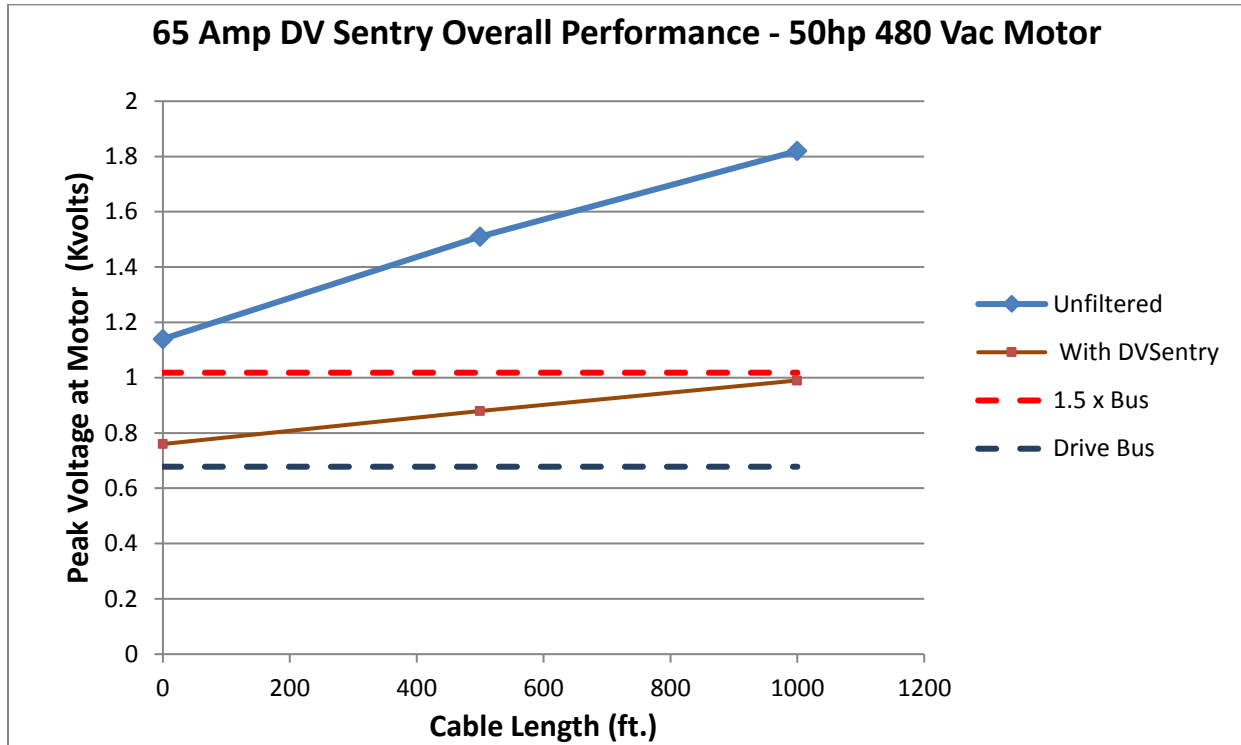

**Figure 3-1: Typical Performance Chart**

### Altitude Derating

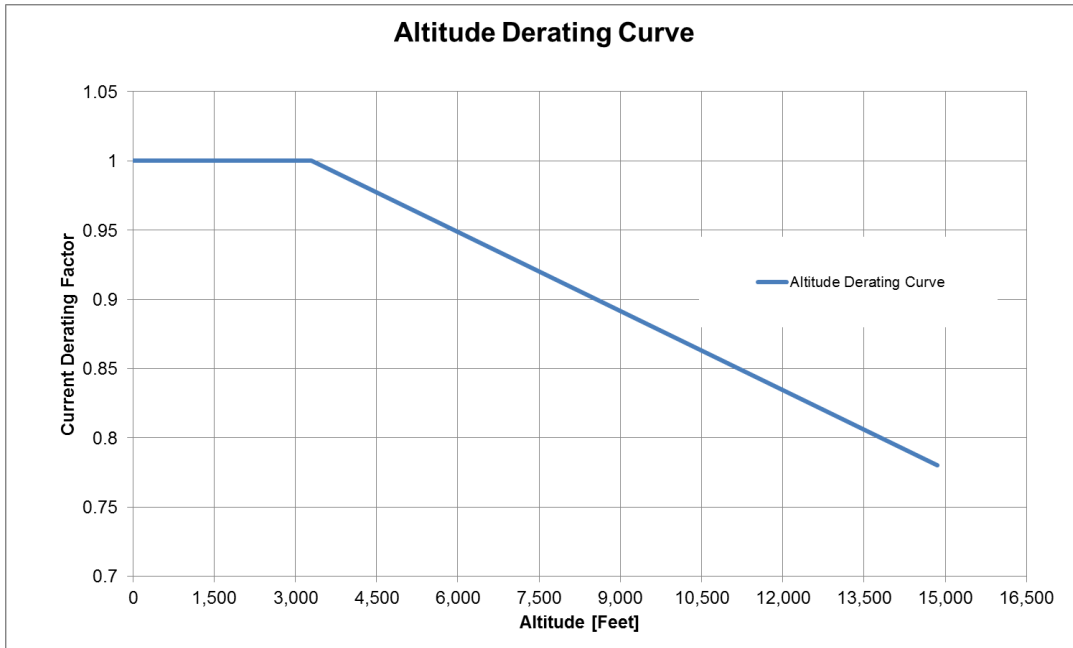

Figure 3-2: Altitude Derating Curve

### Motor Frequency Derating

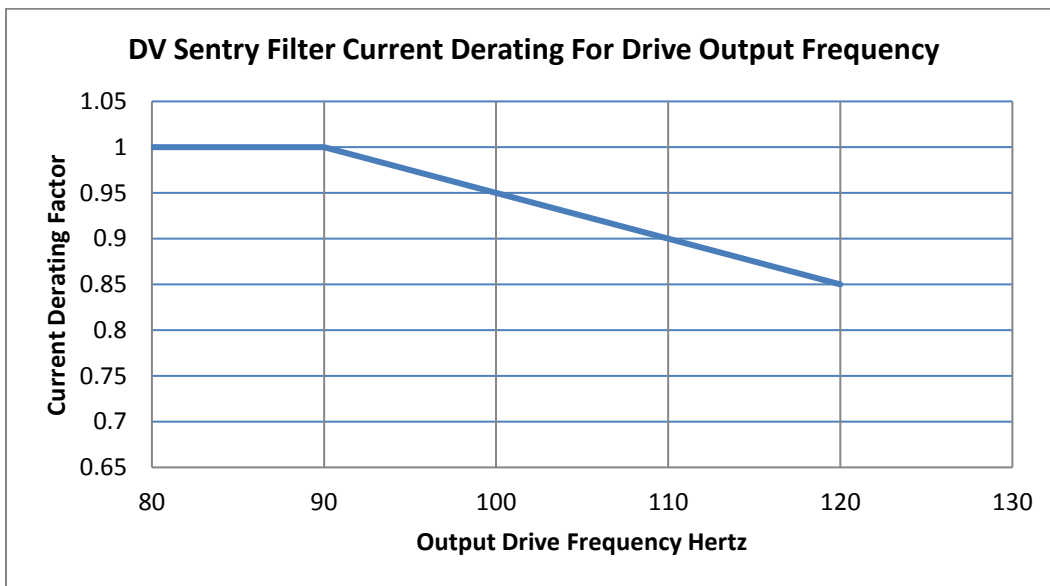

Figure 3-3: Current Derating for Drive Output Frequency

## 4. HOW TO SELECT

### Selection Guide

The dV Sentry motor protection filter is intended for use on inverter duty motors. It will typically be used with lead lengths up to 1,000 feet. The dV Sentry motor protection filter will provide both common mode and differential mode reduction to prevent overvoltage that can occur due to reflected wave phenomena. The differential mode filtering reduces EMI, increases motor life, and reduce cables voltage stress. The added common mode protection will reduce bearing failures, degradation of cable insulation to ground, and further reduce EMI.

The suitability of this filter for a specific application must therefore be determined by the customer. In no event, will MTE Corporation assume responsibility or liability for any direct or consequential damages resulting from the use or application of this filter. Nor will MTE Corporation assume patent liability with respect to the use of information, circuits or equipment described in this instruction manual.

**NOTE: For non-inverter duty motors, please refer to MTE's [SineWave Guardian](#) filter.**

The dV Sentry motor protection filters are available in Panel, NEMA 1/2, and 3R mechanical configurations.

**Please verify information below for proper selection:**

- Lead Length:** This product is suitable for applications with motor leads up to 1,000 ft. Contact MTE Application Engineering for possible longer applications.
- Voltage:** Input voltage from 208V – 600V. See Table 3-1: Performance Specifications (p5) for specification.
- \*Current Rating:** Support for 3 Amps – 600 Amps.
- Switching Frequency:** Support for carrier frequency of 2kHz – 10kHz. See Table 3-1: Performance Specifications (p5).
- Drive Output Frequency:** Support for 0Hz to 90Hz without derating, >90Hz to 120Hz with derating. See Figure 3-3: Current Derating for Drive Output Frequency (p8) for derating curve.
- Temperature:** Maximum ambient temperature, 60C (open), 50C (enclosed). See Table 3-1: Performance Specifications (p5) for specification.
- Altitude:** 3,300 feet above sea level without derating. See Figure 3-2: Altitude Derating Curve (p8) for derating curve.
- Enclosure Type:** Panel, NEMA 1/2 & NEMA 3R, see Enclosures (p4) for enclosure descriptions.
- Motor Insulation Class:** Verify motor meets inverter duty standards per NEMA MG1 Section 31.

**\* NOTE: dV Sentry filters can be paralleled for higher current ratings. Contact MTE Application Engineering for more information.**

## Understanding the dV Sentry Part Number:

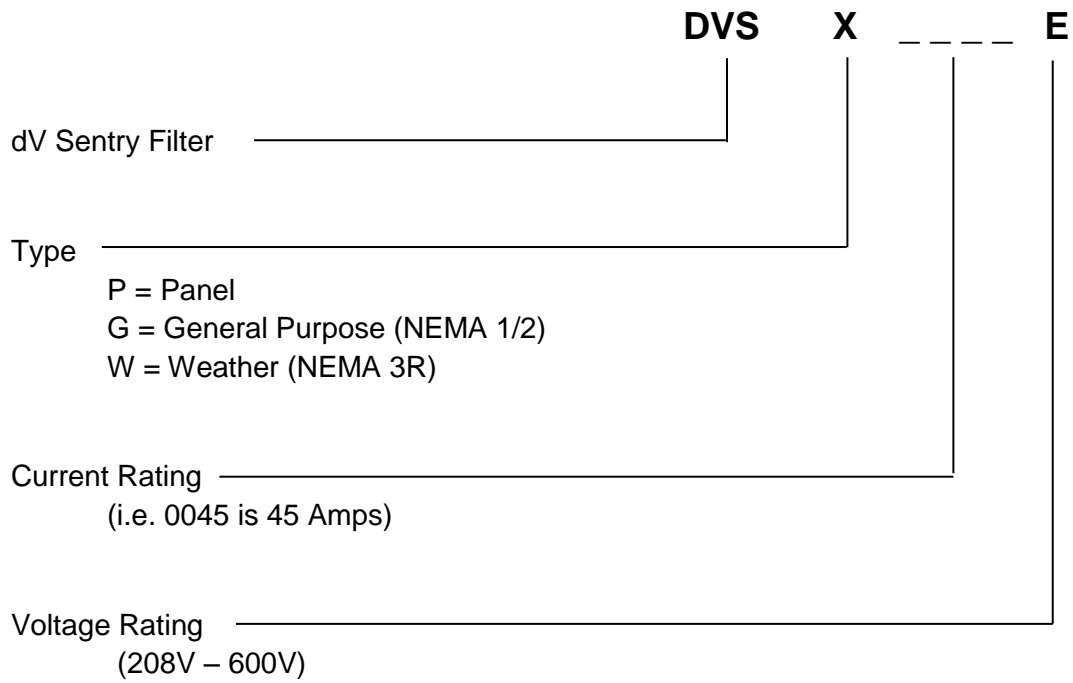

## Part Number Selection Tables

Table 4-1: Panel Selection Table

208V Motor HP	240V Motor HP	380V Motor KW	480V Motor HP	550V-600V Motor HP	Filter Amp Rating	Part Number	App. Wt. (lbs.)	Open Magnetics (in.) (H x W x D)	Resistor Panel (in.) (H x W x D)
.5	.75	0.5-1.1	0.5-1.5	0.5-2	3	<a href="#">DVSP0003E</a>	7	9.1 x 6.7 x 7.7	-
.75	1	1.5	2	3	4	<a href="#">DVSP0004E</a>	7	9.1 x 6.7 x 7.7	-
1.5	2	2.2-3	3	5	7	<a href="#">DVSP0007E</a>	7	9.1 x 6.7 x 7.7	-
2	3	4	5	7.5	9	<a href="#">DVSP0009E</a>	7	9.1 x 6.7 x 7.7	-
3	4	5.5	7.5	10	12	<a href="#">DVSP0012E</a>	7	9.1 x 6.7 x 7.7	-
5	5.5	7.5	10	15	17	<a href="#">DVSP0017E</a>	8	9.1 x 6.7 x 7.5	-
5.5	7.5	11	15	20	22	<a href="#">DVSP0022E</a>	11	9.1 x 6.7 x 8.2	-
7.5	10	-	20	25	27	<a href="#">DVSP0027E</a>	11	9.1 x 6.7 x 8.2	-
10	12.5	15	25	30	35	<a href="#">DVSP0035E</a>	15	12.0 x 9.0 x 7.9	-
12.5	15	18.5-22	30	40	45	<a href="#">DVSP0045E</a>	15	12.0 x 9.0 x 7.9	-
15	20	-	40	50	55	<a href="#">DVSP0055E</a>	22	12.0 x 9.0 x 8.2	-
20	25	30	50	60	65	<a href="#">DVSP0065E</a>	31	12.0 x 9.0 x 11.0	-
25	30	37	60	75	80	<a href="#">DVSP0080E</a>	30	12.0 x 9.0 x 11.0	-
30	40	45-55	75	100	110	<a href="#">DVSP0110E</a>	36	12.0 x 9.0 x 11.0	-
40	50	-	100	125	130	<a href="#">DVSP0130E</a>	66	13.5 x 13.6 x 7.9	18.4 x 5.0 x 7.0
50	60	75-90	125	150	160	<a href="#">DVSP0160E</a>	72	13.5 x 13.6 x 9.0	18.4 x 5.0 x 7.0
60	75	110	150	200	200	<a href="#">DVSP0200E</a>	69	13.5 x 13.6 x 9.0	18.4 x 5.0 x 7.0
75	100	132	200	250	250	<a href="#">DVSP0250E</a>	89	15.0 x 15.1 x 10.3	18.4 x 5.0 x 7.0
100	125	160	250	300	305	<a href="#">DVSP0305E</a>	94	15.2 x 15.1 x 10.4	18.4 x 5.0 x 7.0
125	150	185-200	300	350	365	<a href="#">DVSP0365E</a>	124	15.1 x 15.1 x 11.8	18.4 x 5.0 x 7.0
150	175	-	350	450	415	<a href="#">DVSP0415E</a>	124	15.1 x 15.1 x 11.8	18.4 x 5.0 x 7.0
175	225	250	400-450	500-550	515	<a href="#">DVSP0515E</a>	157	14.9 x 15.1 x 13.3	18.4 x 5.0 x 7.0
200	250	315	500	600	600	<a href="#">DVSP0600E</a>	170	15.1 x 15.1 x 13.4	18.4 x 5.0 x 7.0

## Part Number Selection Tables

**Table 4-2: Enclosed NEMA 1/2 Selection Table**

208V Motor HP	240V Motor HP	380V Motor KW	480V Motor HP	550V-600V Motor HP	Filter Amp Rating	Part Number	App. Wt. (lbs.)	NEMA 1/2 Enclosure (in.) (H x W x D)
.5	.75	0.5 – 1.1	0.5 – 1.5	0.5 - 2	3	<a href="#">DVSG0003E</a>	19	13.2 x 13.0 x 13.1
.75	1	1.5	2	3	4	<a href="#">DVSG0004E</a>	19	13.2 x 13.0 x 13.1
1.5	2	2.2 - 3	3	5	7	<a href="#">DVSG0007E</a>	19	13.2 x 13.0 x 13.1
2	3	4	5	7.5	9	<a href="#">DVSG0009E</a>	19	13.2 x 13.0 x 13.1
3	4	5.5	7.5	10	12	<a href="#">DVSG0012E</a>	19	13.2 x 13.0 x 13.1
5	5.5	7.5	10	15	17	<a href="#">DVSG0017E</a>	19	13.2 x 13.0 x 13.1
5.5	7.5	11	15	20	22	<a href="#">DVSG0022E</a>	23	13.2 x 13.0 x 13.1
7.5	10	-	20	25	27	<a href="#">DVSG0027E</a>	23	13.2 x 13.0 x 13.1
10	12.5	15	25	30	35	<a href="#">DVSG0035E</a>	25	13.2 x 13.0 x 13.1
12.5	15	18.5 - 22	30	40	45	<a href="#">DVSG0045E</a>	25	13.2 x 13.0 x 13.1
15	20	-	40	50	55	<a href="#">DVSG0055E</a>	32	13.2 x 13.0 x 13.1
20	25	30	50	60	65	<a href="#">DVSG0065E</a>	42	13.2 x 13.0 x 13.1
25	30	37	60	75	80	<a href="#">DVSG0080E</a>	43	13.2 x 13.0 x 13.1
30	40	45 - 55	75	100	110	<a href="#">DVSG0110E</a>	43	13.2 x 13.0 x 13.1
40	50	-	100	125	130	<a href="#">DVSG0130E</a>	97	24.0 x 17.1 x 18.5
50	60	75 - 90	125	150	160	<a href="#">DVSG0160E</a>	111	24.0 x 17.1 x 18.5
60	75	110	150	200	200	<a href="#">DVSG0200E</a>	116	24.0 x 17.1 x 18.5
75	100	132	200	250	250	<a href="#">DVSG0250E</a>	166	33.9 x 18.3 x 20.9
100	125	160	250	300	305	<a href="#">DVSG0305E</a>	171	33.9 x 18.3 x 20.9
125	150	185 - 200	300	350	365	<a href="#">DVSG0365E</a>	202	33.9 x 18.3 x 20.9
150	175	-	350	450	415	<a href="#">DVSG0415E</a>	202	33.9 x 18.3 x 20.9
175	225	250	400 – 450	500 - 550	515	<a href="#">DVSG0515E</a>	329	51.3 x 27.7 x 24.9
200	250	315	500	600	600	<a href="#">DVSG0600E</a>	340	51.3 x 27.7 x 24.9





## Part Number Selection Tables

Table 4-3: Enclosed NEMA 3R Selection Table

208V Motor HP	240V Motor HP	380V Motor KW	380V Motor HP	480V Motor HP	550V-600V Motor HP	Filter Amp Rating	Part Number	App. Wt. (lbs.)	NEMA 3R Enclosure (in.) (H x W x D)
.5	.75	0.5 – 1.1	0.5 – 1.5	0.5 – 1.5	0.5 - 2	3	<a href="#">DVSW0003E</a>	29	15.5 x 11.0 x 12.0
.75	1	1.5	2	2	3	4	<a href="#">DVSW0004E</a>	29	15.5 x 11.0 x 12.0
1.5	2	2.2 - 3	3	3	5	7	<a href="#">DVSW0007E</a>	29	15.5 x 11.0 x 12.0
2	3	4	5.5	5	7.5	9	<a href="#">DVSW0009E</a>	29	15.5 x 11.0 x 12.0
3	4	5.5	7.5	7.5	10	12	<a href="#">DVSW0012E</a>	29	15.5 x 11.0 x 12.0
5	5.5	7.5	10	10	15	17	<a href="#">DVSW0017E</a>	30	15.5 x 11.0 x 12.0
5.5	7.5	11	15	15	20	22	<a href="#">DVSW0022E</a>	33	15.5 x 11.0 x 12.0
7.5	10	-	-	20	25	27	<a href="#">DVSW0027E</a>	33	15.5 x 11.0 x 12.0
10	12.5	15	20	25	30	35	<a href="#">DVSW0035E</a>	36	15.5 x 11.0 x 12.0
12.5	15	18.5 - 22	25 – 30	30	40	45	<a href="#">DVSW0045E</a>	36	15.5 x 11.0 x 12.0
15	20	-	-	40	50	55	<a href="#">DVSW0055E</a>	76	24.0 x 12.5 x 23.0
20	25	30	40	50	60	65	<a href="#">DVSW0065E</a>	85	24.0 x 12.5 x 23.0
25	30	37	50	60	75	80	<a href="#">DVSW0080E</a>	85	24.0 x 12.5 x 23.0
30	40	45 - 55	60 – 75	75	100	110	<a href="#">DVSW0110E</a>	90	24.0 x 12.5 x 23.0
40	50	-	-	100	125	130	<a href="#">DVSW0130E</a>	142	33.9 x 18.3 x 26.0
50	60	75 - 90	100 – 120	125	150	160	<a href="#">DVSW0160E</a>	158	33.9 x 18.3 x 26.0
60	75	110	150	150	200	200	<a href="#">DVSW0200E</a>	161	33.9 x 18.3 x 26.0
75	100	132	175	200	250	250	<a href="#">DVSW0250E</a>	177	33.9 x 18.3 x 26.0
100	125	160	220	250	300	305	<a href="#">DVSW0305E</a>	172	33.9 x 18.3 x 26.0
125	150	185 - 200	250 – 270	300	350	365	<a href="#">DVSW0365E</a>	212	33.9 x 18.3 x 26.0
150	175	-	-	350	450	415	<a href="#">DVSW0415E</a>	202	33.9 x 18.3 x 26.0
175	225	250	340	400 – 450	500 - 550	515	<a href="#">DVSW0515E</a>	342	51.3 x 27.7 x 30.0
200	250	315	430	500	600	600	<a href="#">DVSW0600E</a>	353	51.3 x 27.7 x 30.0

## 5. HOW TO INSTALL

### Installation Checklist

 <b>WARNING</b>	<p>Prior to installation, please review the safety instructions on pages 1 &amp; 2. Failure to practice this can result in body injury!</p>
 <b>WARNING</b>	<p>Input and output wiring to the filter should be performed by authorized personnel in accordance with NEC and all local electrical codes and regulations.</p> <p>The filter is designed for use with copper conductors with a minimum temperature rating of 75 degrees C.</p>

The dV Sentry filters are supplied in the following mechanical configurations:

- Panel assemblies (3A-110A): Reactor and resistor are assembled on a panel and pre-wired together.
- Modular assemblies (130A-600A): Resistors are pre-wired to a terminal block on a panel and shipped with a modular reactor.
- Floor mounted general purpose NEMA 1/2 & 3R cabinets (3A - 600A): Reactor and resistor/resistor panel are supplied in a cabinet with all items pre-wired together.

**NOTE: 3A – 110A panel mounted assemblies are designed for mounting horizontally (base) or vertically (back panel) in the customer’s enclosure. Vertically mounted filters must have terminal block on top.**

**130A – 600A modular units are designed for horizontal (base) mounting only.**

#### Minimum Required Space:

When determining the internal temperature rise and cooling requirements of the enclosure, include the power dissipation of the filter along with all the other components located in the panel. A general guideline is to allow a side clearance of four (4) inches and a vertical clearance of six (6) inches for proper heat dissipation and access within the enclosure. Clearances may be less if proper ventilation exists. Filter components must operate within temperatures specified in this manual or filter operating life will be compromised. Also, be aware of minimum electrical clearances as defined by the appropriate system safety standard(s). Open panel dV Sentry filters generate heat and should be positioned away from heat sensitive components. Avoid locations where the filter would be subjected to excessive vibrations. Locate the filter as close to the inverter as possible.

General purpose NEMA 1/2 and 3R enclosed filters are designed for floor mounting in an environment suitable for the enclosure type. Do not install in or near a corrosive environment. Avoid locations where the filter would be subjected to excessive vibrations. Allow a minimum side and back clearance of eight (8) inches and front clearance of thirty-six (36) inches for proper heat dissipation and access.

## Grounding

 <b>WARNING</b>	The filter must always be grounded with a grounding conductor connected to ground terminals.
	For panel mounted units, ensure a 2" x 2" area is cleaned of paint and varnish on lower mounting bracket for ground connection.

**NOTE: For cable shield grounding follow the drive manufacturer's recommendations.**

### Overtemperature Interlock

An overtemperature interlock circuit should be used in conjunction with thermal switch to turn off the drive to prevent filter damage due to abnormal operating conditions. The temperature switch is normally closed and will open when an internal reactor temperature of 150°C is reached. See Table 5-1 below for contact rating information and the drive user manual for interconnection information.

**Table 5-1: Overtemperature Switch**

<b>NC Switch</b> opens at 150 Deg. +/- 5 Deg. C		
<b>Current Amps</b>	<b>Voltage</b>	<b>Contact Load</b>
6	120 AC	Resistive Loads
3	120 AC	Inductive Loads
3	240 AC	Resistive Loads
2.5	240 AC	Inductive Loads
8	12 VDC	Resistive Loads
4	24 VDC	Resistive Loads

MTE highly recommends the use of the overtemperature switch to prevent damage to the filter in rare instances of overheating from abnormal operating conditions.

## Power Wiring Connection

 <b>WARNING</b>	<p>Input and output power wiring to the filter should be performed by authorized personnel in accordance with the NEC and all local electrical codes and regulations.          Cable lugs and mounting hardware are provided by the customer.</p>
	<p>Any extremely low or high resistance readings indicate miswiring and may result in damage to filter components if not corrected.</p>
	<p>On NEMA 3R enclosures, CAB-26AP and larger, no live parts shall be mounted below 8 inches from the bottom of the enclosure.</p>

Verify that the power source to which the filter is to be connected is in agreement with the nameplate data on the filter. A fused disconnect switch or circuit breaker should be installed between the filter and its source of power in accordance with the requirements of the NEC and all local electrical codes and regulations. Refer to the drive user manual for selection of the correct fuse rating and class.

For 3A – 110A panel mounted filter applications, interconnection between the filter, its power source, and the drive is shown in Figure 5-2: Open Panel and Enclosed Diagram (p18).

For 130A – 600A open panel filter applications, interconnection between the filter, its power source, the resistor panel, and the drive is shown in Figure 5-3: Modular Diagram (p19).

For all filters supplied in general purpose NEMA 1/2 & 3R cabinets, interconnection between the filter, its power source, and the drive is shown in Figure 5-2: Open Panel and Enclosed Diagram (p18).

Wire gauge range and terminal torque requirements for the dV Sentry and the resistor panel are shown in Table 5-2: Torque Ratings (p20).

Refer to the drive user manual for instructions on interconnecting the drive and motor and the correct start-up procedures for the drive.

The filter is designed for use with copper conductors with a minimum temperature rating of 75 degrees C.

### Basic Schematic Diagram

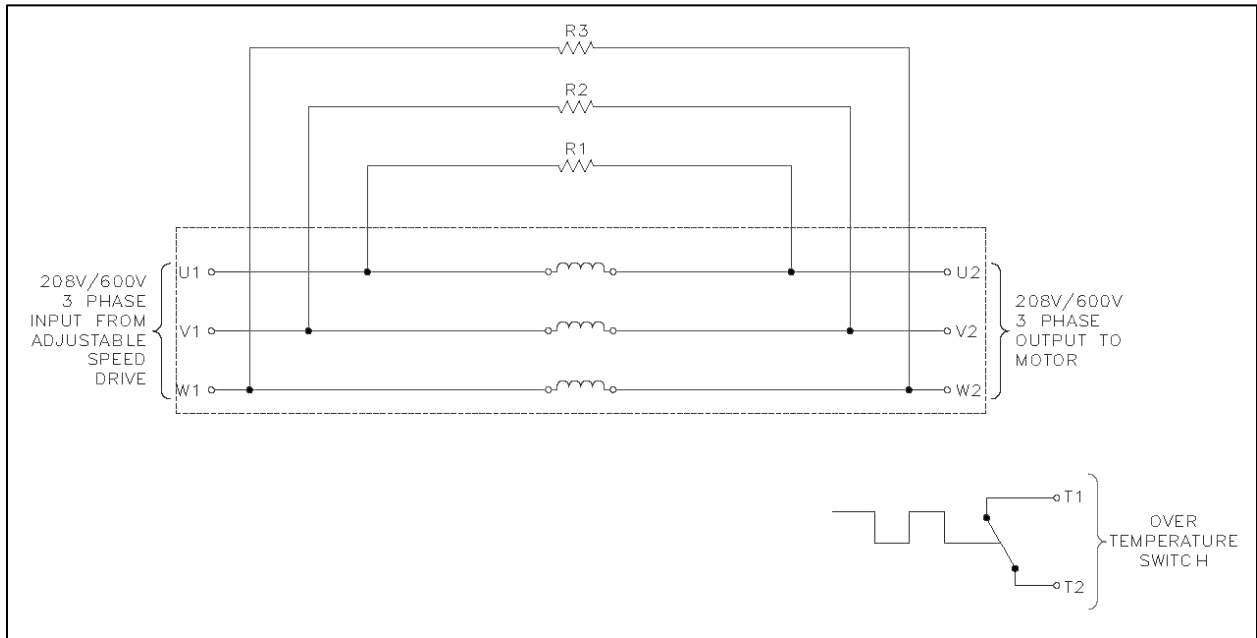

Figure 5-1: Basic Schematic Diagram

### Interconnection Diagram – Panel (3A-110A) and Enclosed (3A-600A)

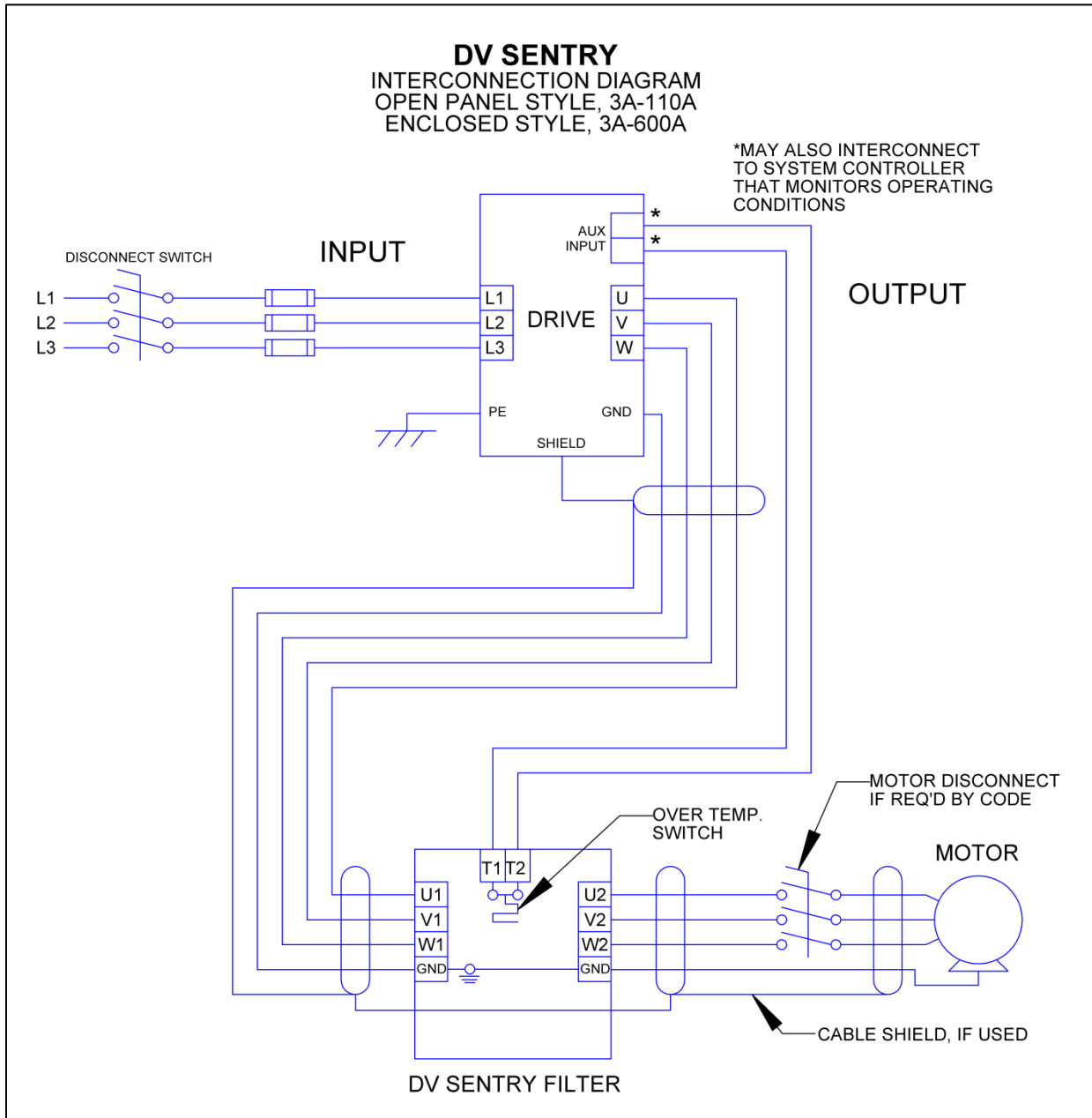
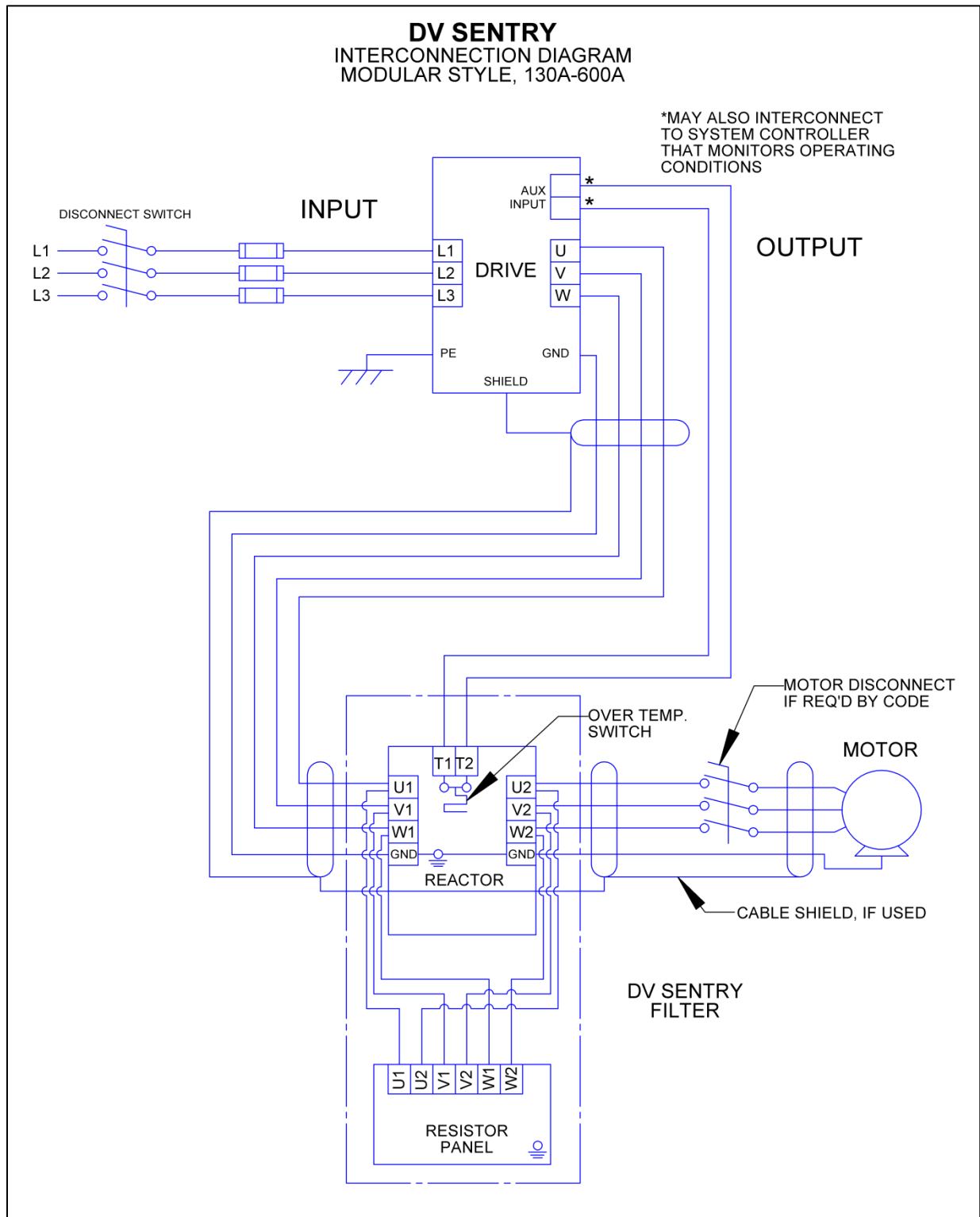

Figure 5-2: Open Panel and Enclosed Diagram

### Interconnection Diagram – Modular (130A-600A)



**Figure 5-3: Modular Diagram**

## Torque Ratings

**Table 5-2: Torque Ratings**

Filter Rating (Amps)	dV Sentry Terminals				
	Input /Output Power U1-V1-W1 / U2-V2-W2		Resistor Panel Terminals U1-V1-W1 / U2-V2-W2		
	Recommended Minimum Wire Size (AWG)	Terminal Torque (in-lbs.)	Resistor Panel Part Number	Recommended Wire Size (AWG)	Terminal Torque (in-lbs.)
3	14	16	N/A	N/A	N/A
5	14	16	N/A	N/A	N/A
7	14	16	N/A	N/A	N/A
9	14	16	N/A	N/A	N/A
12	14	16	N/A	N/A	N/A
17	12	16	N/A	N/A	N/A
22	10	16	N/A	N/A	N/A
27	10	16	N/A	N/A	N/A
35	8	16	N/A	N/A	N/A
45	8	16	N/A	N/A	N/A
55	6	16	N/A	N/A	N/A
65	6	N/A	N/A	N/A	N/A
80	4	N/A	N/A	N/A	N/A
110	2	N/A	N/A	N/A	N/A
130	1	N/A	RESPANEL-012	14	16
160	4(2x) or 2/0	N/A	RESPANEL-012	14	16
200	3(2x) or 3/0	N/A	RESPANEL-012	14	16
250	1 (2x) or 250kcmil	N/A	RESPANEL-013	14	16
305	2/0 (2x)	N/A	RESPANEL-013	14	16
365	3/0 (2x)	N/A	RESPANEL-013	14	16
415	4/0 (2x)	N/A	RESPANEL-013	14	16
515	300kcmil (2x)	N/A	RESPANEL-014	14	16
600	350kcmil(2x)	N/A	RESPANEL-014	14	16

**NOTE:** To prevent flexing or bending of the coil windings attached to dV Sentry filter, use appropriate strain relief to prevent stress on terminals. For flat copper terminal tabs, use two wrenches to tighten customer provided cable mounting hardware.



**NOTE:** Refer to reference drawings for termination wire ranges.



## 6. START-UP

### Safety Precautions

Before start-up, observe the following warnings and instructions:

 <b>WARNING</b>	<p>Internal components of the filter are at line potential when the filter is connected to the drive. This voltage is extremely dangerous and may cause death or severe injury if you come in contact with it.</p>
	<p>Use extreme caution to avoid contact with line voltage when checking for power. <b>INJURY OR DEATH MAY RESULT IF SAFETY PRECAUTIONS ARE NOT OBSERVED.</b></p>
	<p>Damage to equipment or serious injury may occur if the inverter start-up procedures are not observed.</p>
 <b>Caution</b>	<p>Damage to the filter may occur if the appropriate output carrier frequency is not observed.</p>

### Sequence of Operation

1. Read and follow safety precautions.
2. After installation, ensure that:
  - a. All filter ground terminals are connected to ground.
  - b. Power wiring to the utility, drive, filter and motor is in accordance with the power wiring connection diagrams shown in installation instructions section.
3. Check that moisture has not condensed on the filter components. If moisture is present, do not proceed with start-up until the moisture has been removed.
4. Disconnect filter output terminals from the motor.
5. Set the drive switching frequency to the appropriate setting.
  - a. 2kHz – 10kHz (3A – 110A Filters)
  - b. 2kHz – 5kHz (130A – 600A Filters)
6. Connect filter temperature safety overload switch into the control circuit so that the drive will shut down in an overload situation.
7. Confirm that drive voltage is present at the input terminals (U1, V1, W1) of the filter.
8. Confirm that drive voltage is present at the output terminals (U2, V2, W2) of the filter.
9. Connect the filter output to the motor.
10. Refer to the drive user manual for the drive start-up procedure. Observe all safety instructions in the drive user manual.

## 7. TROUBLESHOOTING

 <b>WARNING</b>	<p>When properly installed, this equipment has been designed to provide maximum safety for operating personnel.</p> <p>However, hazardous voltages and elevated temperatures exist within the confines of the enclosure. Servicing should therefore be performed by qualified personnel only and in accordance with OSHA Regulations.</p>
	<p>High voltage is used in the operation of this filter. Use Extreme caution to avoid contact with high voltage when operating, installing or repairing this filter. <b>INJURY OR DEATH MAY RESULT IF SAFETY PRECAUTIONS ARE NOT OBSERVED.</b></p>

To aid in troubleshooting, a basic schematic diagram, two interconnection diagrams, and a troubleshooting guide that lists potential problems and solutions are included:

**Figure 5-1: Basic Schematic Diagram (p17)**

**Figure 5-2: Open Panel and Enclosed Diagram (p18)**

**Figure 5-3: Modular Diagram (p19)**

**Table 7-1: Troubleshooting Guide (p23)**

**Table 7-1: Troubleshooting Guide**

<b>PROBLEM:</b> Voltage is not present at the filter input terminals.	
<b>Possible cause:</b>	Power to the filter is turned off or shut down.
<b>Solution:</b>	Turn power on; check drive errors.
<b>Possible cause:</b>	One or more external line fuses are blown.
<b>Solution:</b>	Verify the continuity of line fuses in all phases. Replace as necessary.
<b>Possible cause:</b>	Damage to drive – dV Sentry interconnect cables.
<b>Solution:</b>	Replace damaged cables.
<b>Possible cause:</b>	Drive setup parameters are incorrect.
<b>Solution:</b>	Verify motor current, voltage, and shutdown parameters are valid.
<b>PROBLEM:</b> dV Sentry filter runs Hot	
<b>Possible cause:</b>	Normal operation, reactor > 150° C and resistors > 300° C.
<b>Solution:</b>	Caution: Parts are very hot and may cause burns. Follow installation guidelines for clearance and check for adequate air flow.
<b>Possible cause:</b>	Motor coil damage; windings shorted.
<b>Solution:</b>	Replace motor; inspect wiring.
<b>Possible cause:</b>	Heat buildup within enclosure.
<b>Solution:</b>	Provide clearance and venting for filter components.
<b>Possible cause:</b>	Heat buildup within enclosure.
<b>Solution:</b>	Check carrier frequency and overload settings.
<b>Possible cause:</b>	Multiple motor applications create complex loading and resonances with dV Sentry filter.
<b>Solution:</b>	dV Sentry filters can be paralleled for higher current ratings. Contact MTE Application Engineering for more information.